

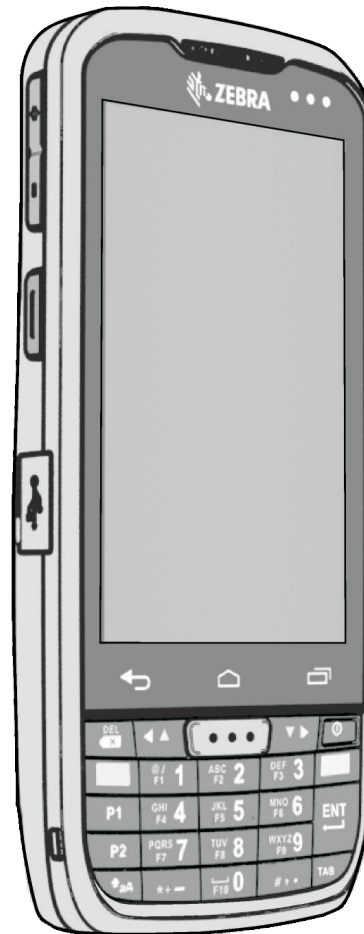

MC36



Wireless terminal equipment

User Guide



MC36

User Guide

MN002339A02

Rev.A

July 2017

Revision History

The following is a list of guidelines first draft several changes:

Change	Date	Description
A01 Rev. A	14/11/15	The first version
A02 Rev.A	04/07/17	Scan Demo doesn't support through Camera.

TABLE OF CONTENTS

Revision History	iii
----------------------------	-----

About This Guide

Introduce	xi
Documentation Set	xi
Configurations	xi
Chapter Descriptions.	xii
Notational Conventions	xii
Icon conventions	xiii
Related Documents	xiii
Service Information.	xiii

Chapter 1 Getting Started

MC36 Features	1-1
Unpacking.	1-3
Setup.	1-3
Installing the SIM Card.	1-3
Installing an Optional microSD Card	1-6
Installing the Battery	1-8
Installing an Optional microSD Card	1-8
Charging LED Status	1-9
Powering On the MC36	1-9
Replacing the 2,940 mAh Battery	1-10
Replacing the 4,410 mAh Battery	1-12

Replacing the microSD Card.	1-14
Battery Management.	1-16
Monitor Battery Usage.	1-16
Low Battery Notification.	1-17
Battery Optimization.	1-18
Turning Off the Radios	1-18
Setting the Date and Time	1-18
Display Setting.	1-19
Setting the Screen Brightness	1-19
Setting Screen Rotation.	1-19
Setting Screen Timeout Setting.	1-20
Setting Font Size	1-20
Setting Touch Key Light	1-20
Touch Mode.	1-21
General Sound Setting	1-22
Programmable Buttons Setting	1-24

Chapter 2 Using the MC36

Introduce	2-1
Home Screen	2-1
Status Bar.	2-3
Status Icons	2-3
Notification Icons.	2-4
Managing Notifications.	2-4
Application Shortcuts and Widgets.	2-5
Adding an Application or Widget to the Home Screen.	2-5
Moving Items on the Home Screen	2-5
Removing an App or Widget from the Home Screen.	2-6
Folders.	2-6
Creating a Folder	2-6
Naming Folders	2-6
Removing a Folder	2-7
Changing the Home Screen Wallpaper	2-7
Using the Touchscreen	2-7
Applications.	2-8
Accessing Applications	2-9
Switching Between Recent Applications	2-9
Un-Locking the Screen	2-10
Resetting the Device	2-12
Performing a Soft Reset.	2-12

Performing a Hard Reset	2-12
Suspend Mode.	2-13

Chapter 3 Applications

File Manager	3-1
People.	3-2
Adding People	3-2
Editing People	3-2
Deleting People	3-3
Camera	3-3
Taking Photos	3-3
Taking a PanoramicPhoto	3-3
Recording Videos.	3-4
Gallery.	3-4
Working with Albums	3-5
Share an Album	3-6
Get Album Information.	3-6
Delete Album.	3-6
Working with Photos.	3-6
Viewing and Browsing Photos.	3-6
Rotating a Photo	3-7
Cropping a Photo.	3-7
Setting a Photo as a Contact Icon	3-8
Get Photo Information	3-8
Share a Photo	3-9
Deleting a Photo.	3-9
Working with Videos.	3-9
Watch video	3-9
Sharing a Video	3-10
Delete a Video	3-10
Movie Studio.	3-11
ScanDemo	3-11
Sound Recorder	3-12

Chapter 4 Data Capture

Linear Imager.	4-1
Scanning Considerations	4-1
Bar Code Capture with Linear Imager or 2D Imager	4-2

Chapter 5 Wireless

Wireless Wide Area Networks	5-1
Sharing the Mobile Data Connection	5-1
USB Tethering	5-1
Bluetooth Tethering	5-2
Portable Wi-Fi Hotspot	5-2
Data Usage	5-3
Disabling Data When Roaming	5-5
Limiting Data Connection to 2G Networks	5-5
SIM Management	5-5
Selecting SIM for 3G Service	5-7
Locking the SIM Card	5-7
Editing the Access Point Name	5-8
Wireless Local Area Networks	5-9
Scanning and connect to the WLAN network	5-9
Configuring a Wi-Fi Network	5-11
Manually Adding a Wi-Fi Network	5-12
Configuring the Device to Use a Static IP Address	5-13
Advanced Wi-Fi Settings	5-14
Modifying a Wi-Fi Network	5-14
Remove a Wi-Fi Network	5-14
Bluetooth	5-15
Bluetooth Power States	5-15
Bluetooth Radio Power	5-15
Enabling Bluetooth	5-15
Disabling Bluetooth	5-15
Discovering Bluetooth Device(s)	5-15
Changing the Bluetooth Name	5-16
Connecting to a Bluetooth Device	5-17
Selecting Profiles on the Bluetooth Device	5-17
Unpairing a Bluetooth Device	5-17
Bluetooth device(s) can find MC36	5-18

Chapter 6 Accessories

MC36 Accessories	6-1
Micro USB Cable	6-2
Single Slot Charge Only Cradle	6-2
Charging the MC36	6-3
Spare Battery Charging	6-3

Chapter 7 Maintenance and Troubleshooting

Maintaining the MC36.	7-1
Battery Safety Guidelines.	7-1
Cleaning Instructions.	7-2
Cleaning the MC36.	7-3
Connector Cleaning.	7-3
Cleaning Cradle Connectors	7-3
Troubleshooting.	7-4

Chapter 8 Technical Specifications

MC36 Technical Specifications.	8-1
--	-----

About This Guide

Introduce

This guide provides information on using the MC36 and accessories.



Note: Screens and windows pictured in this guide are samples and can differ from actual screens.

Documentation Set

The documentation set for the MC36 provides information for specific user needs, and includes:

- MC36 Quick Start Guide - describes how to get the device up and running.
- MC36 User Guide - describes how to use the device.
- MC36 Intergrator Guide– describes how to set up the device and the accessories.

Configurations

This guide covers the following configurations:

Configuration	Radios	Display	Memory	Data Capture	Operating System
MC36A0	WLAN: 802.11b/g/n	4.3" color WVGA	1 GB RAM/8 GB	Linear imager and camera or camera	Android-based, Android Open-Source Project 4.4.2
	WPAN: Bluetooth v4.0		Flash		
	WWAN: GSM/HSPA+/TD-SCDMA				
MC36A9	WLAN: 802.11b/g/n	4.3" color WVGA	1 GB RAM/8 GB	Linear imager and camera or camera	Android-based, Android Open-Source Project 4.4.2
	WPAN: Bluetooth v4.0		Flash		
	WWAN: GSM/HSPA+/TD-SCDMA				
	HF-RFID				

Software Versions

To determine the current software versions touch  >  >  About phone.

- Model number – Displays the model number.
- Android version – Displays the operating system version.
- Kernel version – Displays the kernel version number.
- Build number – Displays the software build number.
- Touch Status and select Serial number – Displays the serial number.

Chapter Descriptions

Topics covered in this guide are as follows:

- Getting Started provides information on getting the MC36 up and running for the first time.
- Using the MC36 provides information for operating the MC36.
- Applications provides information on using applications installed on the MC36.
- Data Capture provides information for capturing bar code data using the linear imager.
- Wireless provides information on the various wireless options.
- Accessories provides information for using the accessories for the MC36.
- Maintenance and Troubleshooting includes instructions on cleaning and provides troubleshooting solutions for potential problems during MC36 operation.
- Technical Specifications provides the technical specifications for the MC36.

Notational Conventions

The following conventions are used in this document:

- Italics are used to highlight the following:
 - Chapters and sections in this and related documents
 - Icons on a screen.
- Bold text is used to highlight the following:
 - Dialog box, window, and screen names
 - Drop-down list and list box names
 - Check box and radio button names
 - Button names on a screen.
- Bullets (•) indicate:
 - Action items
 - Lists of alternatives
 - Lists of required steps that are not necessarily sequential
- Sequential lists (for example, lists that describe step-by-step procedures) appear as numbered lists.

Icon Conventions

The documentation set is designed to give the reader more visual clues. The following graphic icons are used throughout the documentation set. These icons and their associated meanings are described below.



Warning: The word WARNING with the associated safety icon implies information that, if disregarded, could result in death or serious injury, or serious product damage.



Caution: The word CAUTION with the associated safety icon implies information that, if disregarded, may result in minor or moderate injury, or serious product damage.



Note: NOTE contains information more important than the surrounding text, such as exceptions or preconditions. They also refer the reader elsewhere for additional information, remind the reader how to complete an action (when it is not part of the current procedure, for instance), or tell the reader where something is located on the screen. There is no warning level associated with a note.

Related Documents

The following conventions are used in this document:

- MC36 Quick Start Guide, p/n MN002255A01
- MC36 Quick Start Guide, p/n MN002255A01

For the latest version of this guide and all guides, go to <http://www.zebra.com/support>

Service Information

If you have a problem with your equipment, contact Zebra Global Customer Support Center for your region. Contact information is available at <http://www.zebra.com/support>.

When contacting Zebra Global Customer Support Center, please have the following information available:

- Serial number of the unit (found on manufacturing label)
- Model number or product name (found on manufacturing label)
- Software type and version number

Zebra responds to calls by email or telephone within the time limits set forth in support agreements.

If your problem cannot be solved by Zebra Global Customer Support Center, you may need to return your equipment for servicing and will be given specific directions. Zebra is not responsible for any damages incurred during shipment if the approved shipping container is not used. Shipping the units improperly can possibly void the warranty.

If you purchased your product from a Zebra business partner, contact that business partner for support.

Chapter 1 Getting Started

This chapter provides the features of the MC36 and explains how to set it up for the first time.

MC36 Features

Figure 1-1: View

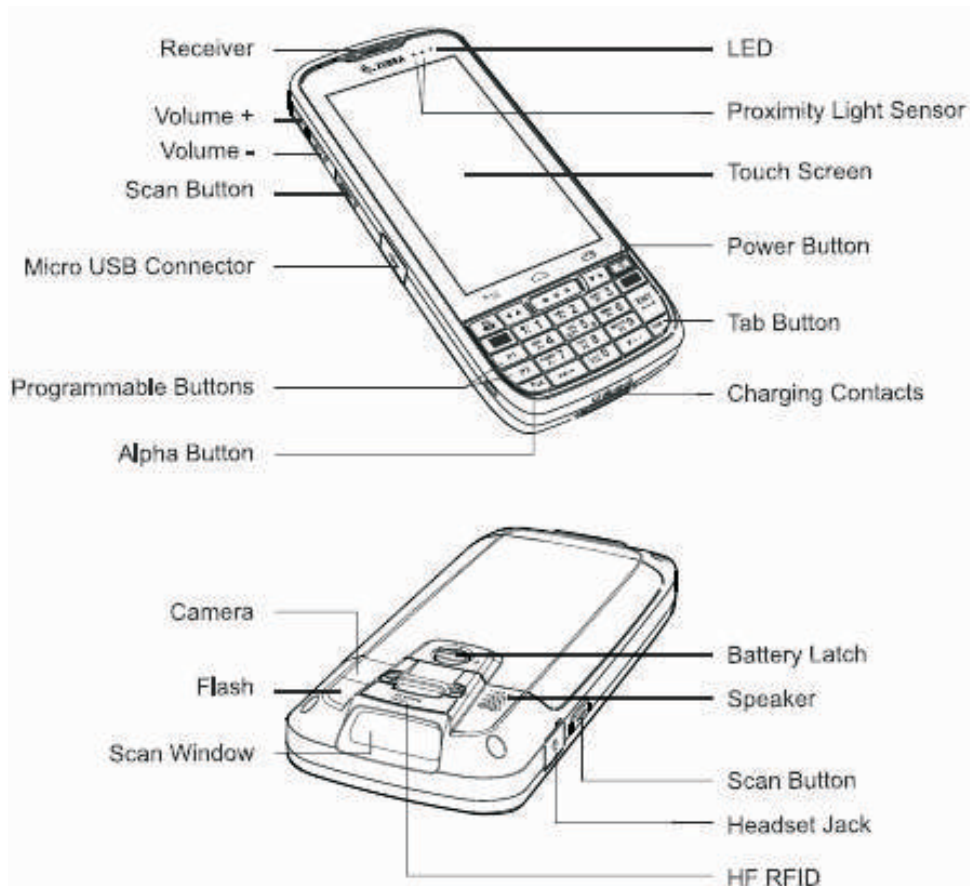

Table 1-1: Front/Back View Features

Number	Description
1	Receiver—Provides audio in handset mode.
2	Power Button—Press and hold to turn on the MC36. Press to turn the screen on or off. Press and hold to select one of these options: <ul style="list-style-type: none"> • Power off- Turn off the MC36. • Reboot-Reboot the MC36 if software stops responding. • Airplane mode-Disable all wireless connections.
3	Touch Screen -Displays all information needed to operate the MC36.
4	LED-Indicates decode functionality. <ul style="list-style-type: none"> • Lights red when scanning is in process. • Lights green when decode successfully. – Indicates battery charge state when charging. – Indicates notifications. Lights blue when a notification is received.
5	Volume Button-Increase and decrease the audio volume.
6	Back button- Displays the previous screen. Closes the keyboard if the on-screen keyboard is open.
7	Home Button - Displays the Home screen with a single touch. Displays recently used applications when held for a short period of time.
8	Programmable Button -To change language input (P1) and adjust the brightness of backlight(P2).
9	USB Port - Provides USB client and host communications.
10	Light Sensor/ Proximity Sensor - Determines ambient light for controlling display backlight intensity and for turning off display when in handset mode.
11	Flash - Provides illumination for the camera.
12	Camera - Take pictures, record video.
13	HFRF ID
14	Headset Jack -Connects to headsets (3.5 mm plug).Note: Do not use 2.5mm to 3.5mm adaptors. Use only headsets with straight plugs.
15	Exit Window - Provides data capture using the linear imager (optional)
16	Charging Contacts - Provides power to the device from cradles and cables.
17	Speakers - Provides audio output for video and music playback.

Unpacking

Carefully remove all protective material from the MC36 and save the shipping container for later storage and shipping. Verify the following items are in the box:

- MC36
- Lithium-ion battery (2,940 mAh or 4,410 mAh)
- Quick Start Guide
- Regulatory Guide.



Note: Power Supply, is required and must be purchased separately.

Inspect the equipment for damage. If any equipment is missing or damaged, contact the Zebra Global Customer Support Center immediately.

Setup

To start using the MC36 for the first time:

- Install the SIM Card
- Install microSD card (optional)
- Install the battery
- Charge the MC36
- Power on the MC36

Installing the SIM Card



Caution:

For proper electrostatic discharge (ESD) precautions to avoid damaging the SIM card. Proper ESD precautions include, but not limited to, working on an ESD mat and ensuring that the user is properly grounded.



Note:

The MC36 accepts micro SIM cards. If using nano SIM card, a third-party SIM adapter is required.

The MC36 requires an activated SIM card. Obtain the card from a service provider.

Procedure:

- 1、 Turn the battery latch to unlock.

Figure 1-2: Unlock SIM Card Holder

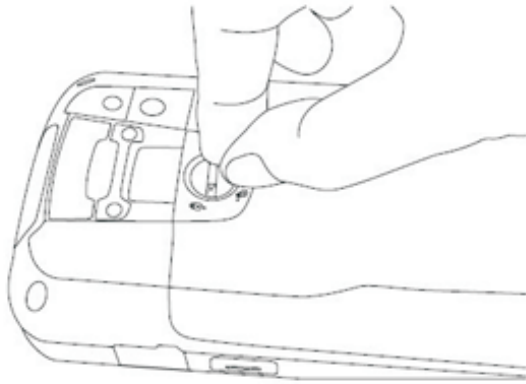

2. Place thumbnail at battery cover notch and lift the battery cover.

Figure 1-3: Unlock SIM Card Holder

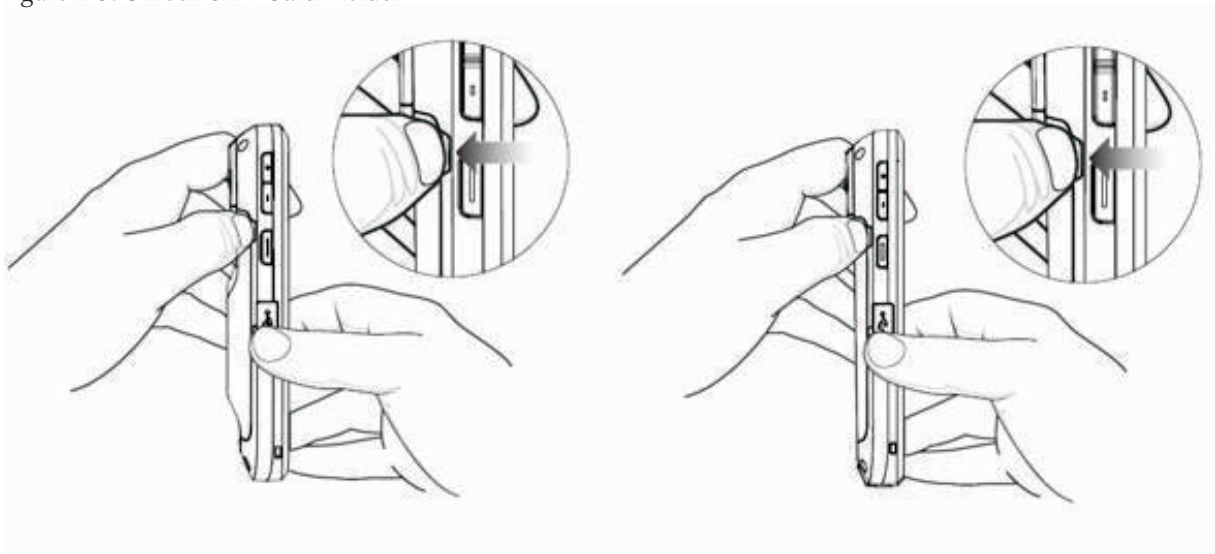

3. Slide the SIM card holder toward the bottom of the MC36 to unlock

Figure 1-4: Unlock SIM Card Holder

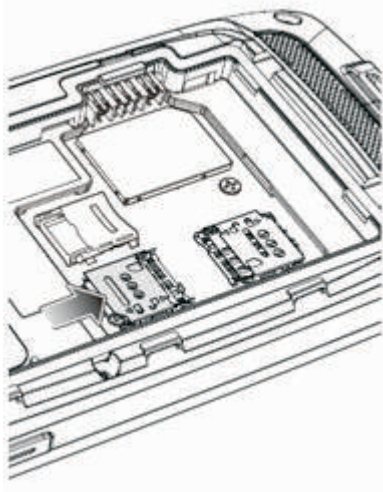

4. Lift the SIM door.
5. Insert the SIM card with the cut edge and the contacts facing up.

Figure 1-5: Install SIM Card

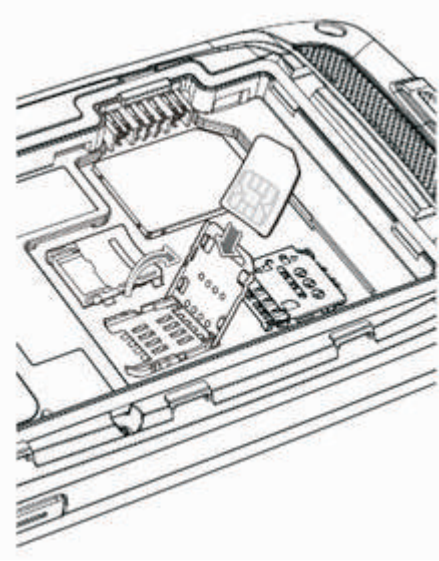

6. Close the SIM card holder.

Figure 1-6: Close SIM Card Holder

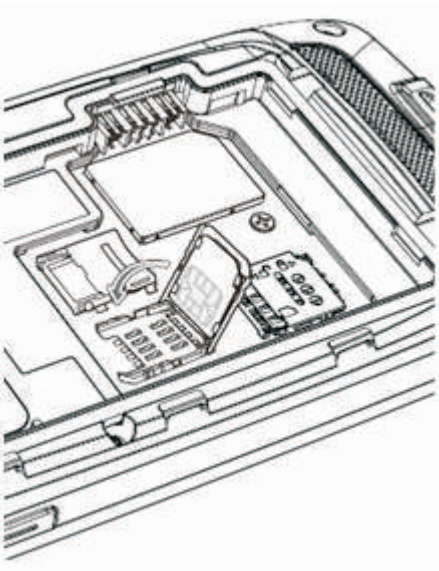

7. Slide the SIM card holder toward the top of the MC36 to lock into place.

Figure1-7: Lock SIM Card Holder

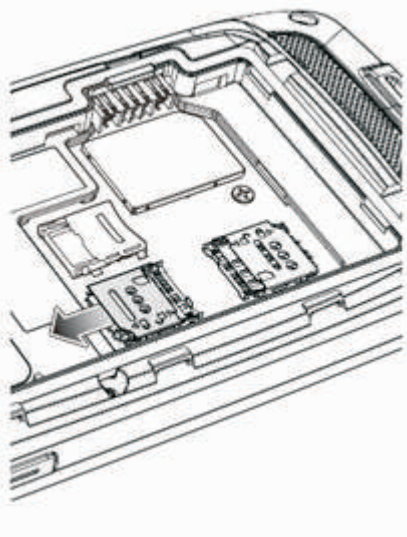

Installing an Optional microSD Card

 **Caution:** For proper electrostatic discharge (ESD) precautions to avoid damaging the SD card. Proper ESD precautions include, but not limited to, working on an ESD mat and ensuring that the user is properly grounded. Changing the microSD card can change the functionality of the MC36.

 **Note:** The MC36 supports microSD cards up to 32 GB.

Procedure:

1. Slide the microSD card door toward the top of the MC36 to unlock.

Figure 1-8: Unlock microSD Card Door

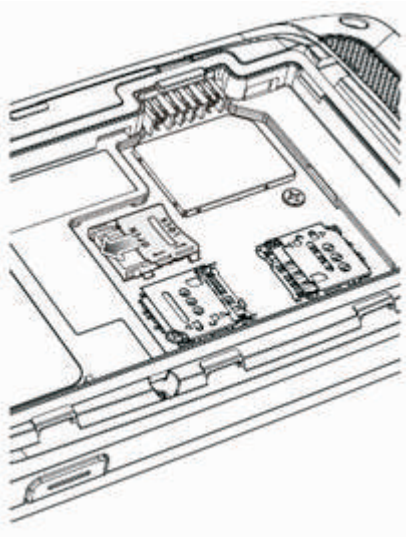

- 2、 Lift the SD card door
- 3、 Align the microSD card with the card holder. Ensure that the contacts on the card are facing down and toward the card holder.
- 4、 Insert the microSD card into the card holder.

Figure 1-9: Insert microSD Card

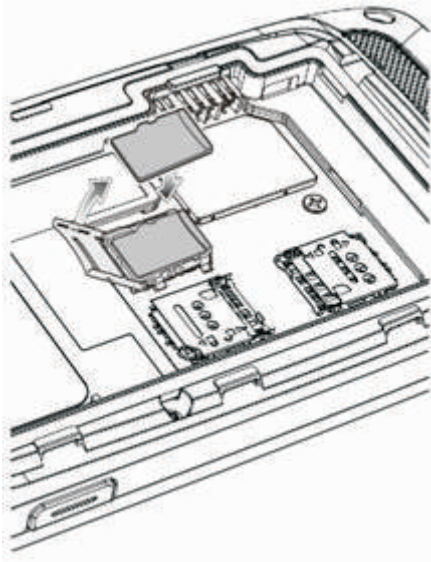

- 5、 Close the SD card door.
- 6、 Slide the SD card door toward the bottom of the MC36 to lock into place.

Figure 1-10: Lock SD Card Door

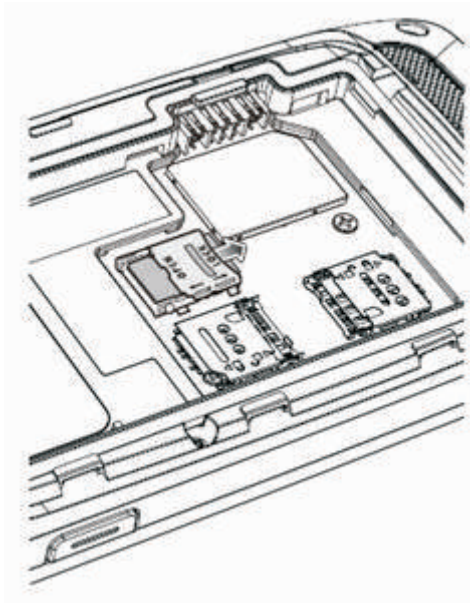

Installing the Battery

There are two sizes of batteries available for the MC36: a 2,940 mAh battery and a 4,410 mAh battery.

Procedure:

1. Align the three tabs on the bottom of the battery with the three slots in the battery compartment.
2. Press the battery down and then rotate until it locks into place.

Figure 1-11: Inserting the 2,940 mAh Battery

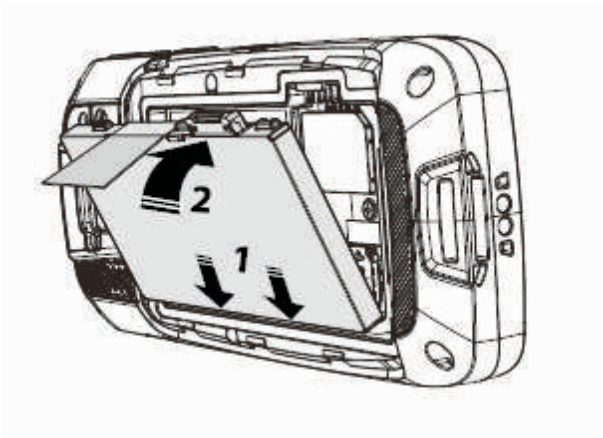
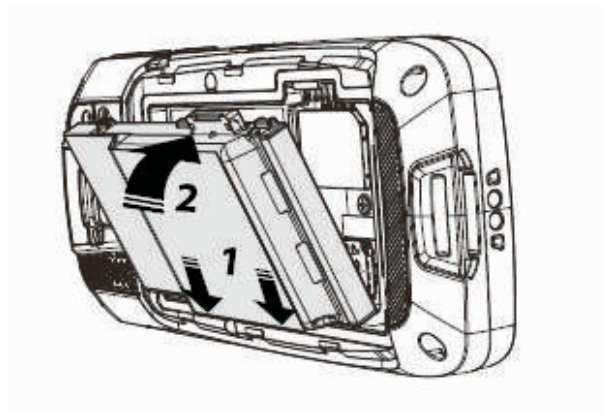
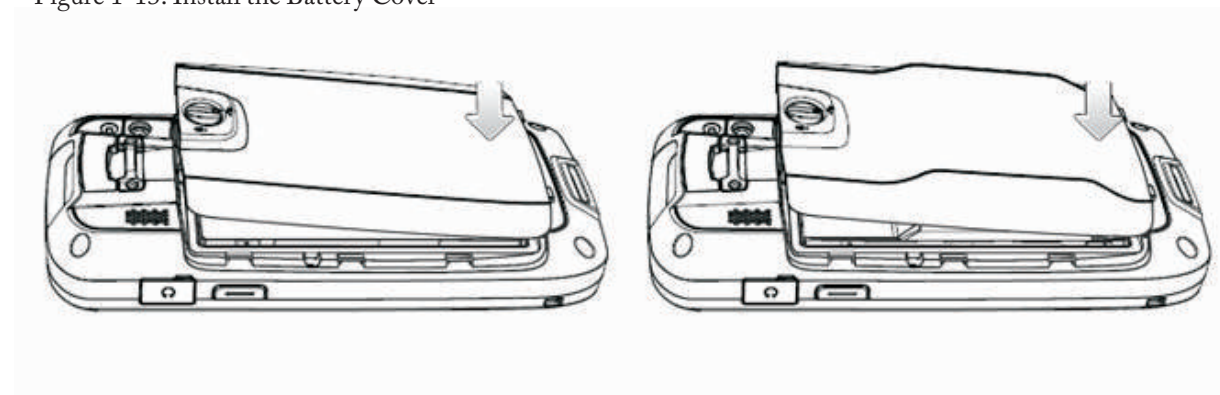

Figure 1-12: Inserting the 4,410 mAh Battery



3. Align the two tabs on the bottom of the battery door with the two slots in the device and press the battery door down until it snaps into place.

Figure 1-13: Install the Battery Cover



4. Press around the edge of the cover to ensure that the battery door is seated properly.
5. Turn the battery latch to lock.

Figure 1-14: Secure Cover

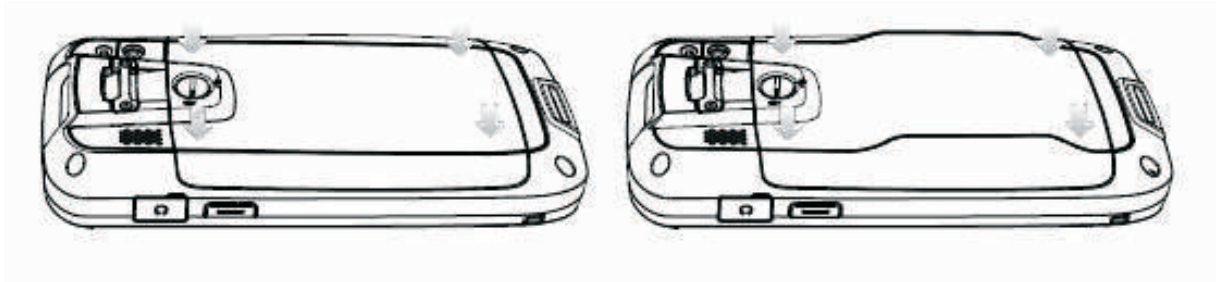

Installing an Optional microSD Card



Caution: Ensure that you follow the guidelines for battery safety described in Battery Safety Guidelines.

Charging LED Status

Table 1-2: Charging LED Status

LED	Description
Slow Flashing Green	MC36 is charging.
Solid Red	Battery is in an extremely low power state (normal solw charging mode)
Solid Green	MC36 is fully charged
Fast Flashing Red	Charging error
Off	Not charging

Charging Temperature

Charge batteries in temperatures from 0 °C to 40 °C (32 °F to 104 °F). Note that charging is intelligently controlled by the MC36. To accomplish this, for small periods of time, the MC36 or accessory alternately enables and disables.

Powering On the MC36



Note: Ensure that the battery cover is properly installed. Otherwise, the MC36 will not power on.

If the MC36 did not turn on when the battery was installed, press the Power button. The LED flashes green and the device vibrates. The splash screen displays for about a minute as the MC36 boots.

Replacing the 2,940 mAh Battery

Procedure:

- 1、 Press the Power button until the menu displays.
- 2、 Touch Power off.
- 3、 Touch OK.
- 4、 Turn the battery latch to unlock.
- 5、 Place thumbnail at notch and lift the battery cover.

Figure 1-15: Remove the Battery Cover

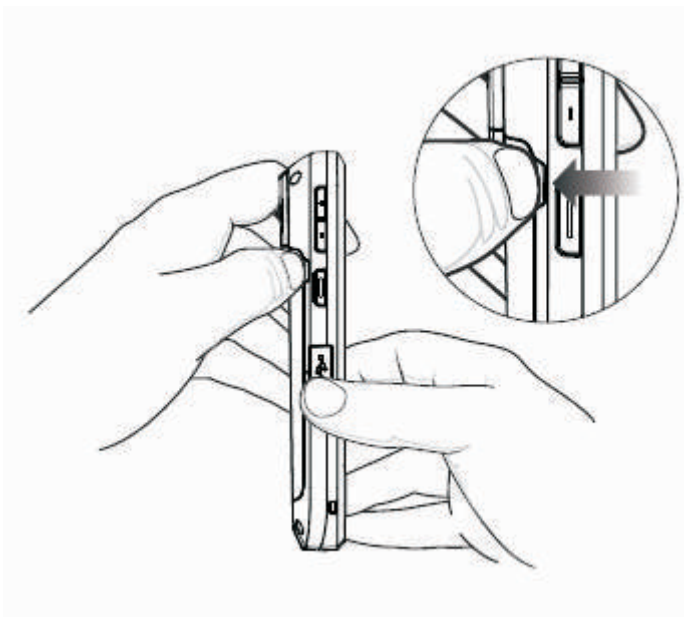

Note: Do not pull the battery tab straight out. Pull at a 45 degree angle.

- 6、 Pull the battery tab down at a 45 degree angle.

Figure 1-16: Remove 2,940 mAh Battery

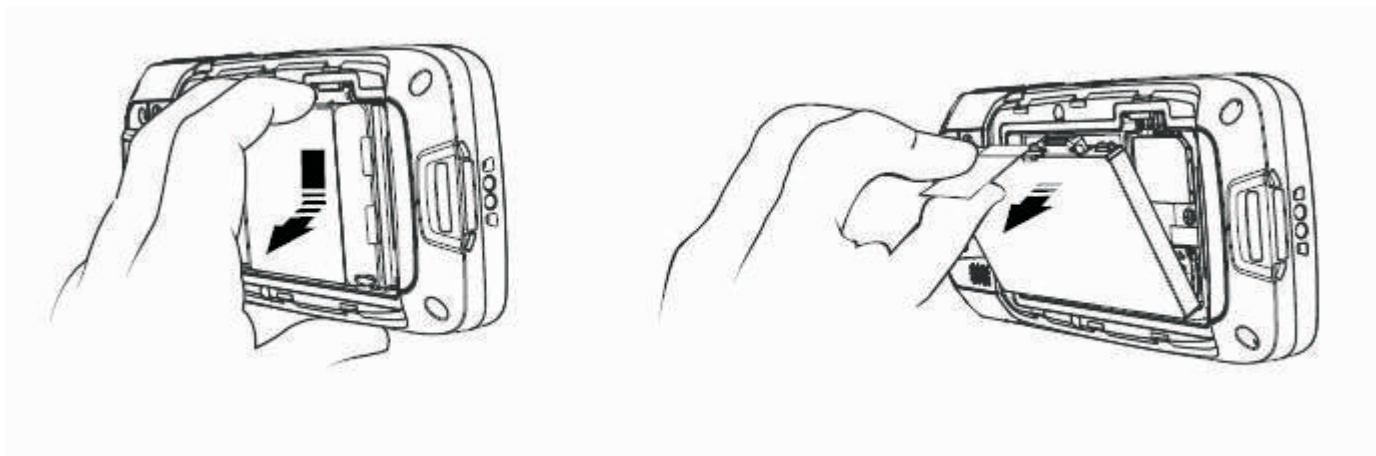

7. Remove the battery from the battery compartment.
8. Align the three tabs on the bottom of the replacement battery with the three slots in the battery compartment.
9. Press the battery down and rotate until it locks into place.

Figure 1-17: Inserting the 2,940 mAh Battery

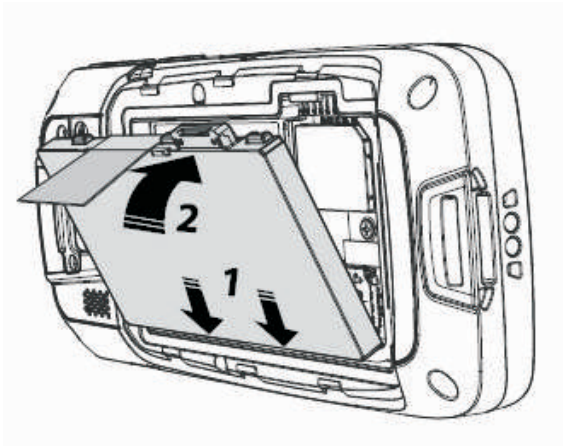

10. Align the two tabs on the bottom of the battery door with the two slots in the device.

Figure 1-18: Align the Battery Cover

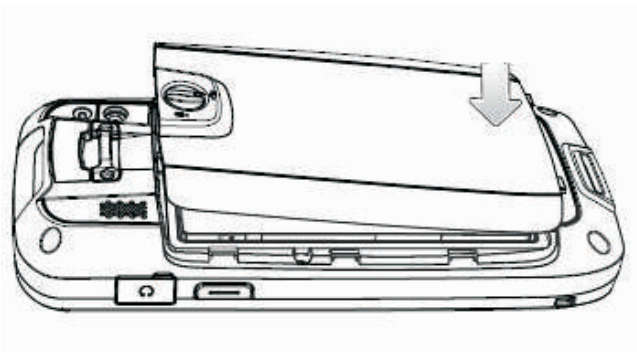

11. Press around the edge of the cover to ensure that the battery door is seated properly.

Figure 1-19: Secure the Battery Cover

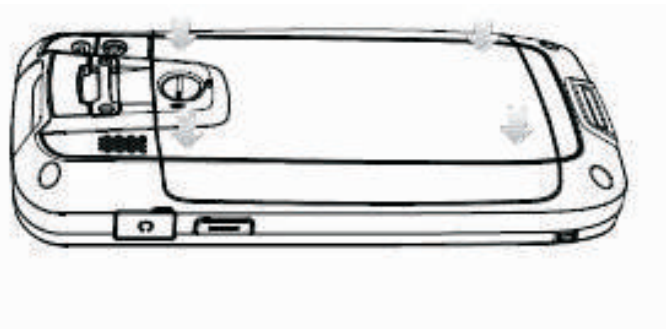

12. Turn the battery latch to lock.
13. Press the Power button to turn on the MC36.

Replacing the 4,410 mAh Battery

Procedure:

1. Press the Power button until the menu displays.
2. Touch Power off.
3. Touch OK.
4. Turn the battery latch to unlock.
5. Place thumbnail at notch and lift the battery cover.

Figure 1-20: Remove the Battery Door

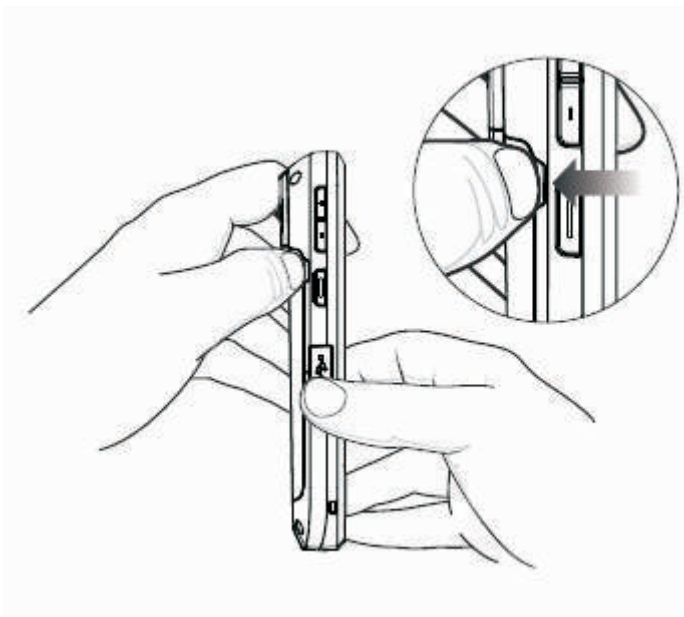

6. With two fingers, press the battery down.

Figure 1-21: Remove 4,410 mAh Battery

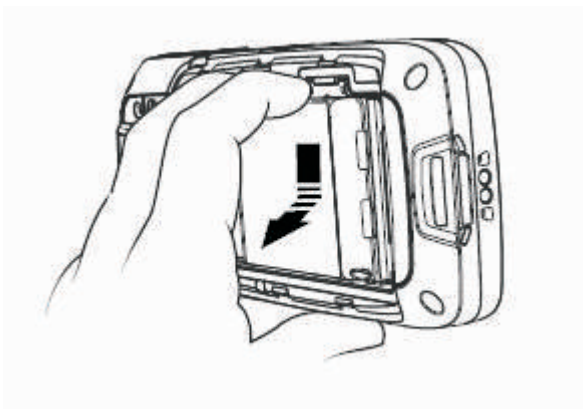

7. Rotate the battery out of the compartment.
8. Align the three tabs on the bottom of the replacement battery with the three slots in the battery compartment.
9. Press the battery down and rotate until it locks into place.

Figure 1-22: Inserting the 4,410 mAh Battery

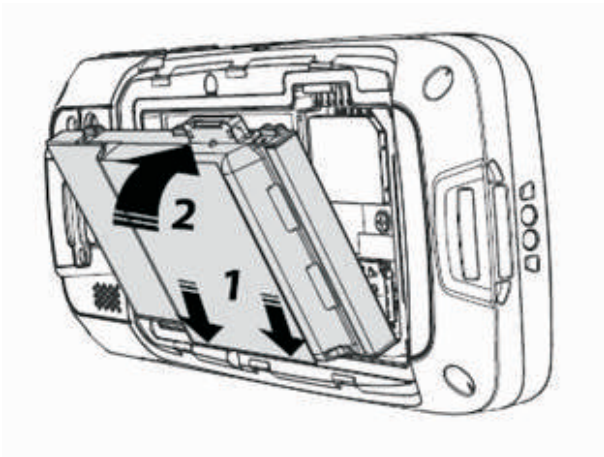

10. Align the two tabs on the bottom of the battery door with the two slots in the device.

Figure 1-23: Align the Battery Cover

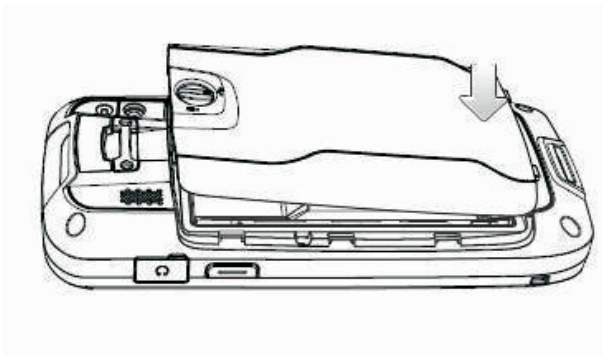

11. Press around the edge of the cover to ensure that the battery door is seated properly.

Figure 1-24: Secure the Battery Cover

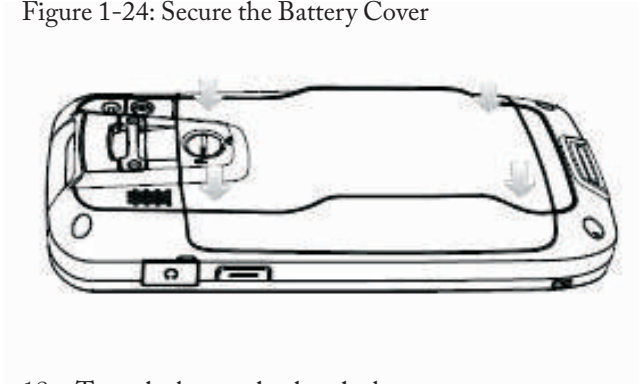

12. Turn the battery latch to lock.
13. Press the Power button to turn on the MC36.

Replacing the microSD Card



Caution: For proper electrostatic discharge (ESD) precautions to avoid damaging the SD card. Proper ESD precautions include, but not limited to, working on an ESD mat and ensuring that the user is properly grounded.

Changing the microSD card can change the functionality of the MC36.

Ensure that you follow the procedures to shut down the MC36 before replacing the microSD card. Data corruption can occur if reading or writing to the microSD card and power is removed.



Note: The MC36 supports microSD cards up to 32 GB.

To replace the microSD card:

Procedure:

1. Press the Power button until the menu displays.
2. Touch Power off.
3. Touch OK.
4. Wait for the device to power off completely.
5. Remove the battery cover.
6. Remove the battery.
7. Slide the microSD card door up to unlock.

Figure 1-25: Unlock microSD Card Door

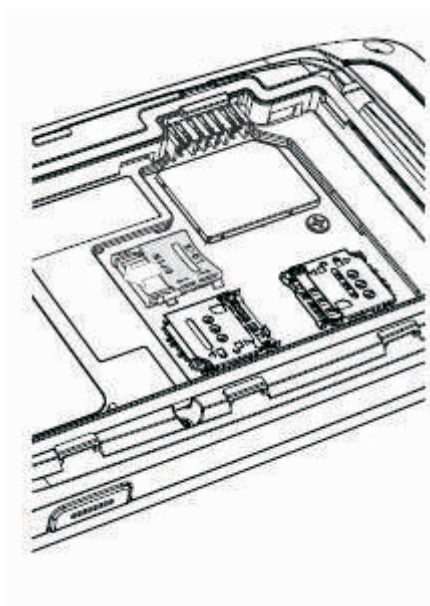

8. Lift the microSD card door.
9. Remove the microSD card from the card holder.
10. Align the replacement microSD card with the card holder. Ensure that the contacts on the card are facing down and toward the card holder.
11. Insert the microSD card into the card holder.

Figure 1-26: Insert microSD Card

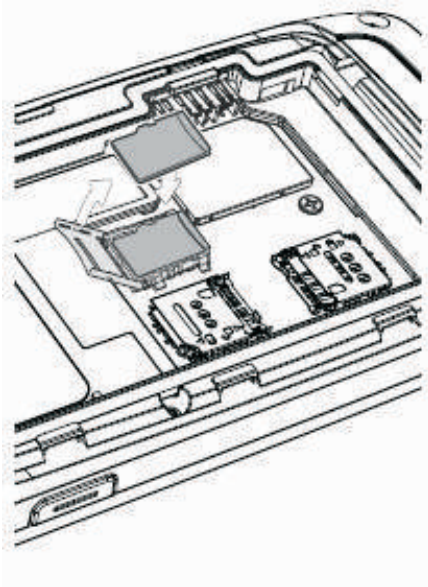

12. Close the microSD card door.
13. Slide the microSD card door down to lock into place.

Figure 1-27: Lock microSD Card Cover

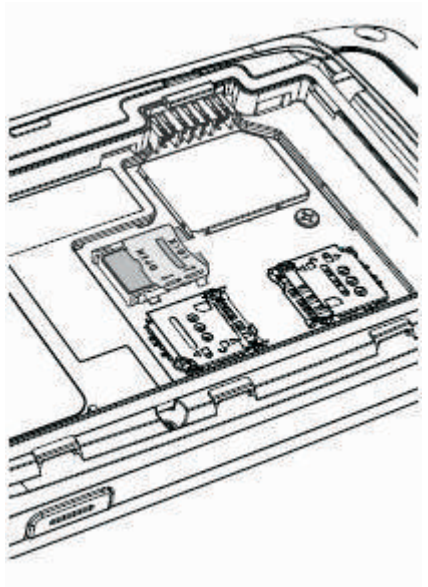

14. Replace the battery.
15. Align the battery door with the back of the device and press the battery door down until it snaps into place.
16. Press the Power button to turn on the device.

Battery Management



Note: Prior to checking the battery charge level, remove the MC36 from any AC power source (cradle or cable).

To check the charge status of the main battery, touch  >  >  About phone > Status. Battery status indicates that the battery is discharging and Battery level lists the battery charge (as a percentage of fully charged).

Monitor Battery Usage

The Battery screen lists which applications consume the most battery power. Also use it to turn off applications that were downloaded if they are consuming too much power.

Touch  >  > Battery.

Figure 1-28: Battery Screen

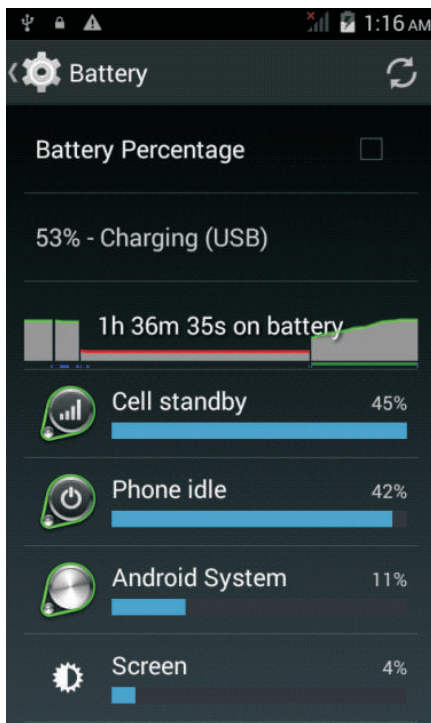

The Battery screen lists the applications using the battery. The discharge graph at the top of the screen shows the rate of the battery discharge since last charged (short periods of time when connected to a charger are shown as thin green lines at the bottom of the chart), and how long it has been running on battery power.

Touch an application in the Battery screen to display details about its power consumption. Different applications display different information. Some applications include buttons that open screens with settings to adjust power use.

Low Battery Notification

When the battery charge level drops below 20% (2,940 mAh battery) or 13% (4,410 mAh battery), the MC36 displays a notice to connect the MC36 to power. The user should charge the battery using one of the charging accessories.

Figure 1-29: Low Battery Notification



When the battery charge drops below 4% (2,940 mAh battery) or 3% (4,410 mAh battery), the MC36 turns off. Anytime the user then tries to power on the MC36, the following screen appears.

The user must charge the MC36 using one of the charging accessories to retain data.

Figure 1-30: Battery Depleted Screen

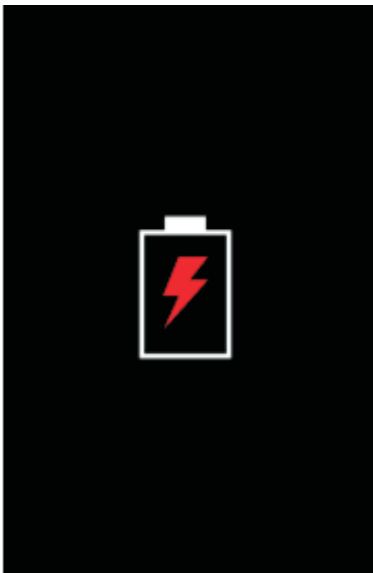

The user must charge the MC36 using one of the charging accessories.

Battery Optimization

Observe the following battery saving tips:

- Leave the MC36 connected to AC power at all times when not in use.
- Set the screen to turn off after a short period of non-use. See Setting Screen Timeout Setting.
- Reduce screen brightness. See Setting the Screen Brightness .
- Turn off all wireless radios when not in use. Note that the global positioning system (GPS) receiver is only turned on when a GPS application is using the GPS radio.
- Turn off automatic syncing for Email, Calendar, Contacts and other applications.
- Use the Power Control widget to check and control the status of radios, the screen brightness, and syncing.
- Minimize use of applications that keep the MC36 from suspending, for example, music, GPS and video applications.

Turning Off the Radios

To turn off all the radios:



Procedure:

- 1、 Press the Power button until the menu appears.
- 2、 Touch Airplane mode. The airplane  appears in the Status bar indicating that all the radios are off.

Setting the Date and Time

The date and time are automatically synchronized when the MC36 is connected to most WAN networks. To manually set the date and time:

Procedure:

- 1、 From the Home screen, touch .
- 2、 Touch .
- 3、 Touch  Date & time.
- 4、 Touch Automatic date & time to disable automatic date and time synchronization.
- 5、 Touch Automatic time zone to disable automatic time zone synchronization.
- 6、 Touch Set date.
- 7、 Move the sliders up and down to select the month, date and year.
- 8、 Touch Done.
- 9、 Touch Set time.
- 10、 Move the sliders up and down to select the hour, minutes and part of the day.
- 11、 Touch Done.
- 12、 Touch Select the time zone.
- 13、 Select the current time zone from the list.

Display Setting

Use Display settings to change the screen brightness, change the background image, enable screen rotation, set sleep time and change font size.

Setting the Screen Brightness

To set the screen brightness:

Procedure:

- 1、 Touch  .
- 2、 Touch  .
- 3、 Touch  Display.
- 4、 Touch Brightness.

Figure 1-31: Brightness Dialog Box

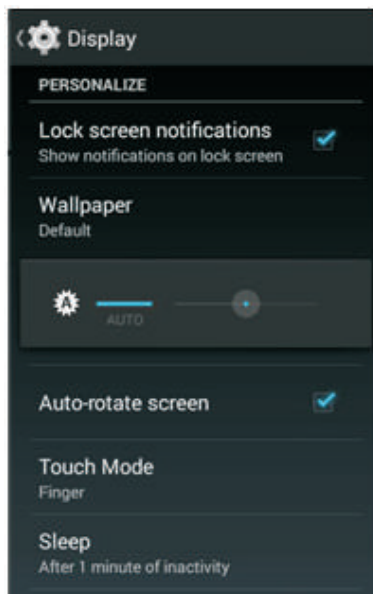



- 5、 Check the Automatic brightness checkbox to set the device to automatically adjust the brightness using the built-in light sensor. Unlock the checkbox to set the brightness manually. Use the slider to set a brightness level.

Setting Screen Rotation

To set the screen rotation:

Procedure:

- 1、 Touch  .
- 2、 Touch  .
- 3、 Touch  Display.
- 4、 Check Auto-rotate screen to set the MC36 to automatically switch orientation when the MC36 is rotated.





Note: The Home screen does not rotate.

Setting Screen Timeout Setting

To set the screen sleep time:



Procedure:

- 1、 Touch  .
- 2、 Touch  .
- 3、 Touch  Display.
- 4、 Touch Sleep.
- 5、 Select one of the sleep values.
 - 15 seconds
 - 30 seconds
 - 1 minute (default)
 - 2 minutes
 - 5 minutes
 - 10 minutes
 - 30 minutes

Setting Font Size

To set the size of the font in system applications:



Procedure:

- 1、 Touch  .
- 2、 Touch  .
- 3、 Touch  Display.
- 4、 Touch Font size.
- 5、 Select one of the font size values.
 - Small
 - Normal (default)
 - Large
 - Extra large

Setting Touch Key Light

The four touch keys under the screen are backlit. Configure the touch key light to save battery power.

Procedure:

- 1、 Touch  .
- 2、 Touch  .
- 3、 Touch  Display.

- 4、 Touch Key light.
- 5、 Select one of the options.
 - Always off (Default)
 - 6 seconds
 - 10 seconds
 - 15 seconds
 - 30 seconds
 - 1 minute
 - Always on

Figure 1-32: Touch Key Light Dialog Box

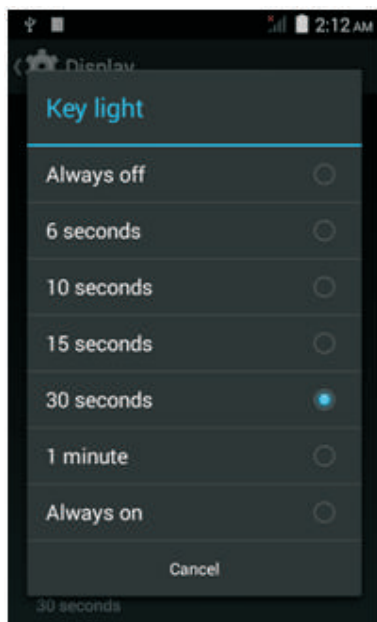

Touch Mode

The MC36 display is able to detect touches using a finger, a conductive-tip stylus or gloved finger.



Note:

A glove can be made of medical latex, leather, cotton or wool.
For optimal performance use Zebra certified stylus.

Procedure:



- 1、 Touch  .
- 2、 Touch  .
- 3、 Touch  Display.
- 4、 Touch Touch Mode.

Figure 1-33: Touch Mode Dialog Box



5. Touch Finger to use a finger or a stylus on the screen or touch Stylus(Glove) to use a finger or a gloved finger on the screen.

General Sound Setting

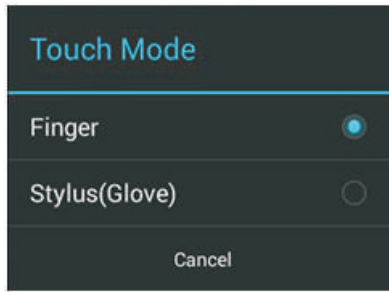
Use the Sounds settings to configure media and alarm volumes. On the Home screen, touch  >  >  Audio profiles > General >  .

Figure 1-34: Sounds Screen

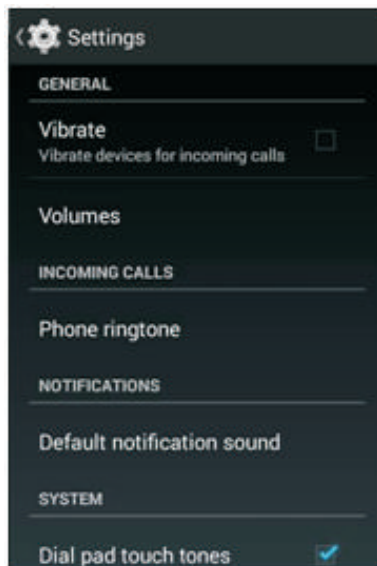

- Vibrate - Check to make the device vibrate when a call is received.
- Volumes - Use to change the volume of media, ringtones, notifications and alarms.

Figure 1-35: Volumes Dialog Box

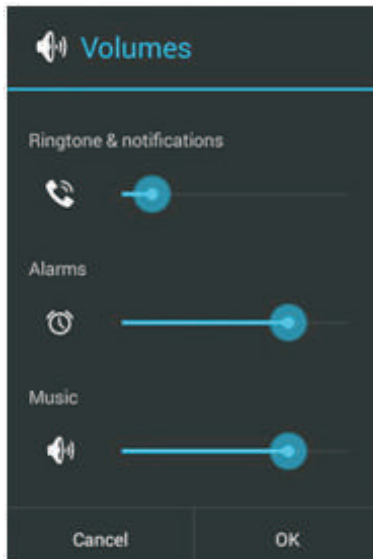

- Phone ringtone - Touch to select a ringtone to sound when an incoming call is received.

- Notification

Default notification sound- Touch to select a sound to play for all system notifications.

- System
 - Dial pad touch tones - Check to play a sound when a phone key is touched.
 - Touch sounds - Check to play a sound when making screen selections.
 - Screen lock sounds - Check to play a sound when locking and unlocking the screen.
 - Vibrate on touch - Check to have the device vibrate when touching soft keys and on certain screen interactions.
- Silent-Touch to select the device silent only when a call is received.
- Meeting- Touch to select the device vibrate only when a call is received.
- Outdoor - Touch to select the device loudest ring and vibrate when a call is received.
- Sound Enhancement- check BesAudEnh to have the device with audio enhancer for earphone.

Programmable Buttons Setting

The function of other buttons and applications can be remapping to the programmable button.

Five buttons which are able to be remapped.

- Central trigger key
- Right side key
- Left side key
- P1
- P2

Procedure:

- 1、 Touch Settings -> Key Programmer

Figure 1-36: Key Programmer Screen



- 2、 Select "FUNC_P1"
- 3、 Touch BUTTON REMAPPING, select one button in the menu, for example Enter, then P1 is functional as Enter.

Figure 1-37: BUTTON REMAPPING Screen

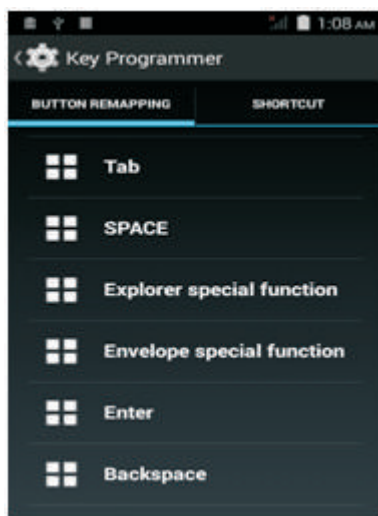

- 4、 Touch shortcut for remapping, select one application in the menu, for example Calculator, then P1 is functional as Calculator.

Figure 1-38: Shot cut Screen

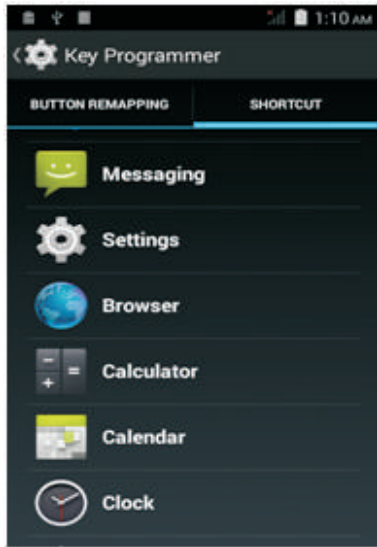

Chapter 2 Using the MC36

This chapter describes the screens, status and notification icons, and controls on the MC36, and provides basic instructions for using the MC36.

Home Screen

The Home screen displays when the MC36 turns on. Depending upon the configuration, the Home screen might appear different. Contact your system administrator for more information.

After a suspend or screen time-out, the Home screen displays with the lock sliders. Slide  to the right toward  to unlock the screen. For screen locking information see Un-Locking the Screen.

Figure 2-1: Home Screen

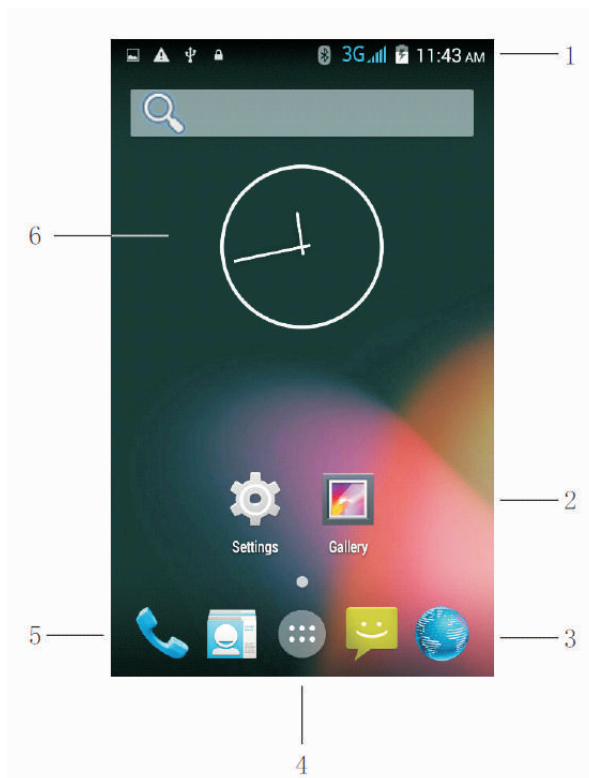

Table 2-1: Home Screen Items

Number	Item	Description
1	Status Bar	Displays the time, status icons (right side), and notification icons (left side). For more information see Status Icons and Managing Notifications.
2	Shortcut Icons	Opens applications installed on the MC36. See Application Shortcuts and Widgets for more information.
3	Browser Icon	Opens the Browser application.
4	All Apps Icon	Opens the APPS window.
5	Phone Icon	Opens the Dialer window.
6	Widgets	Launches stand-alone applications that run on the Home screen. See Application Shortcuts and Widgets for more information.

The Home screen provides additional screen for placement of widgets and shortcuts. Swipe the screen left or right to view the additional screens.

Status Bar

The Status bar displays the time, notification icons (left side) and status icons (right side).

Figure 2-2: Notification and Status Icons

























Table 2-2: Home Screen Items

Item	Description
1	Notification icons.
2	Status icons.

If there are more notifications than can fit in the Status bar, displays indicating that more notifications exist. Open the Notifications panel to view all notifications and status.















Status Icons

Table 2-3: Status Icons

Icons	Description
	Indicates that GPS is in use.
	Indicates that the MC36 is searching location data.
	Indicates that the Alarm is active.
	Indicates that all sounds except media and alarms are silenced and vibrate mode is active.
	Indicates that the ringer is silenced.
	Microphone is muted during a call.
	Indicates that the battery is fully charged.
	Indicates that the battery is partially drained.
	Indicates that the battery charge is low.
	Indicates that the battery charge is low.
	Indicates that the battery is charging.
	Indicates that the Airplane Mode is active. All radios are turned off.
	Indicates that Bluetooth is on.
	Indicates that the MC36 is connected to a Bluetooth device.
	Connected to a Wi-Fi network.
	No Wi-Fi signal.
	Mobile network signal strength.
	No mobile network signal.
	Connected to a 3G network.
	Connected to a HSPA network.
	Connected to an EDGE network
	No SIM card installed.

Notification Icons

Table 2-4: Notification Icons

Icons	Description
	Indicates that more notifications are available for viewing.
	Indicates that data is syncing.
	Indicates that an open Wi-Fi network is available.
	Indicates that a song is playing.
	Indicates that a problem with sign-in or sync has occurred.
	Indicates that the MC36 is uploading data.
	Indicates that the microSD card is almost full.
	Indicates that the MC36 is downloading data when animated and download is complete when static.
	Indicates that the MC36 is connected via USB cable.
	Preparing SD card.
	Indicates that USB debugging is enabled on the MC36.
	Indicates that the MC36 has received a text message.
	Indicates that Bluetooth tethering is active.
	Indicates that USB tethering is active.
	Indicates that Wi-Fi hotspot is active.

Managing Notifications

Notification icons report the arrival of new messages, calendar events, and alarms, as well as ongoing events. When a notification occurs, an icon appears in the Status bar with a brief description. See Table 7: Notification Icons for a list of possible notification icons and their description. Open the Notifications panel to view a list of all the notifications.

To open the Notification panel drag the Status bar down from the top of the screen.

Figure 2-3: Notification Panel

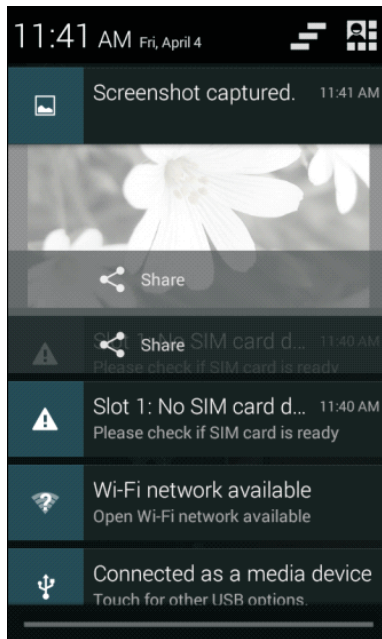

To respond to a notification, open the Notifications Panel and then touch a notification. The Notifications Panel closes and the subsequent activity is dependent on the notification.

To clear all notifications, open the Notifications Panel and then touch . All event-based notifications are removed. Ongoing notifications remain in the list.

To close the Notification Panel, drag the bottom of the Notifications Panel to the top of the screen or touch .

Application Shortcuts and Widgets

Application shortcuts placed on the Home screen allow quick and easy access to applications. Widgets are self-contained applications placed on the Home screen to access frequently used features.

Adding an Application or Widget to the Home Screen

Procedure:

- 1、 Go to the desired Home screen.
- 2、 Touch .
- 3、 Swipe right, if necessary, to find the application icon or widget.
- 4、 Touch and hold the icon or widget until the Home screen appears.
- 5、 Position the icon on the screen and then release.

Moving Items on the Home Screen

Procedure:

- 1、 Touch and hold the item until it floats on the screen.
- 2、 Drag the item to a new location. Pause at the edge of the screen to drag the item onto an adjacent Home screen.
- 3、 Lift finger to place the item on the Home screen.

Removing an App or Widget from the Home Screen

Procedure:

1. Go to the desired Home screen.
2. Touch and hold the application shortcut or widget icon until it floats on the screen.
3. Drag the icon to  **Remove** on the top of the screen and then release.

Folders

Use Folders to organize similar applications together. Touch the folder to open and display items in the folder.

Creating a Folder

To create a folder, there must be at least two app icons on the Home screen.

Procedure:

1. Go to the desired Home screen.
2. Touch and hold on one application icon.
3. Drag the icon and stack on top of another icon.
4. Lift and release.

Naming Folders

Procedure:

1. Touch the folder.

Figure 2-4: Open Folder

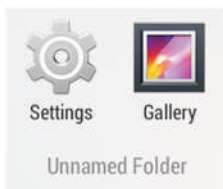

2. Touch the title area and enter a folder name using the keyboard.
3. Touch OK.
4. Touch anywhere on the Home screen to close the folder. The folder name appears under the folder.

Figure 2-5: Renamed Folder

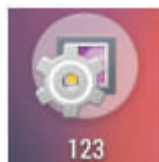

Removing a Folder

Procedure:

- 1、 Touch and hold the folder icon until it enlarges and the device vibrates.
- 2、 Drag the icon to  **Remove** and release.

Changing the Home Screen Wallpaper



Note: Use of Live Wallpaper may reduce battery life.

Procedure:

- 1、 Long press the empty place.
- 2、 Touch Wallpaper.
- 3、 Select an image store on the device from Pick image and set wallpaper.
- 4、 Select Video Wallpaper to use an animated wallpaper image.
- 5、 Slide right to select Live Wallpaper to use a live wallpaper image.
- 6、 Touch Set wallpaper.

Using the Touch screen

Use the multi-touch sensitive screen to operate the device.



- Touch - Touch to:
 - select items on the screen
 - type letters and symbols using the on-screen keyboard
 - press on-screen buttons.
- Touch and Hold - Touch and hold:
 - an item on the Home screen to move it to a new location or to the trash.
 - an item in Apps to create a shortcut on the Home screen.
 - the Home screen to open a menu for customizing the Home screen.
 - an empty area on the Home screen until the menu appears.
- Drag - Touch and hold an item for a moment and then move finger on the screen until reaching the new position.
- Swipe - Move finger up and down or left and right on the screen to:
 - unlock the screen
 - view additional Home screens
 - view additional application icons in the Launcher window
 - view more information on an application's screen.
- Double-tap - Tap twice on a web page, map, or other screen to zoom in and out.
- Pinch - In some applications, zoom in and out by placing two fingers on the screen and pinching them together (to zoom out) or spreading them apart (to zoom in).

Applications

The APPS screen displays icons for all installed applications. Table 8: Applications lists the applications installed on the MC36.

Table 2-5: Applications

Icons	Description
	Browser - Use to access the Internet or intranet.
	Calculator - Provides the basic and scientific arithmetic functions.
	Calendar - Use to manage events and appointments.
	Camera - Take photos or record videos. For more information see Viewing Photos and Videos.
	Clock - Use to schedule alarms for appointments or as a wake-up.
	ScanDemo - Enables data capture using 1D or 2D Scanner.
	Downloads - lists all downloads files.
	Email - Use to send and receive email.
	File Manager - Organize and manage files on the MC36. See File Browser for more information.
	Gallery - Use to view photos stored on the microSD card. For more information, see Gallery for more information.
	Messaging - Send SMS and MMS messages.
	Movie Studio - Create movie videos. See Movie Studio for more information.
	Music - Play music stored on the microSD card.
	People - Use to manage contact information. People for more information.
	Phone - Use to make phone calls.
	Search - Use the Google search engine to search the Internet and the MC36.
	Settings - Use to configure the MC36.
	Sound Recorder - Use to record audio.
	Scan Config - Allow the user to scan barcode in any application without adding any customization.
	To Do - Use to write down the to-do issues.

Icons	Description
	SIM Toolkit – Use to set up and launch SIM card.
	MobiControl Stage – Use to manage MC36.

Accessing Applications

All applications installed on the device are accessed using the APPS window.

Procedure:

1. Touch .

Figure 2-6: APPS Window

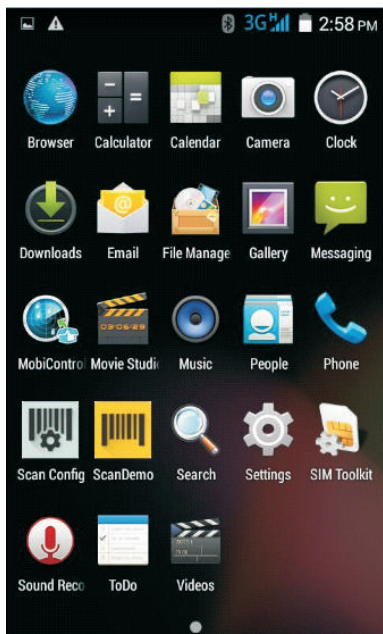

2. Slide the APPS window left or right to view more application icons. Touch an icon to open the application.



Note: See [Application Shortcuts and Widgets](#) for information on creating a shortcut on the Home screen.

Switching Between Recent Applications

Procedure:



1. Touch  and hold. A window appears on the screen with icons of recently used applications.

Figure 2-7: Recently Used Applications

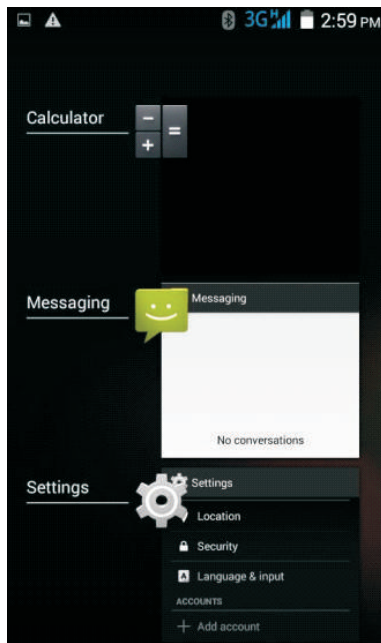

- 2、 Slide the window up and down to view all recently used applications.
- 3、 Swipe left or right to remove application from the list and force close the application.
- 4、 Touch an icon to open it or press  to return to the current screen.

Un-Locking the Screen

Use the Lock screen to protect access to data on the MC36. Some email account require locking the screen.

When locked, a pattern, PIN or password is required to unlock the device. Press the Power button to lock the screen. The device also locks after a pre-defined time-out.

Press and release the Power button to wake the device.

The Lock screen displays. Slide  to the right toward  to unlock the screen. If the Pattern screen unlock feature is enabled, the Pattern screen appears instead of the Lock screen.

If the PIN or Password screen unlock feature is enabled, enter the PIN or password after unlocking the screen.

Figure 2-8: Lock Screen

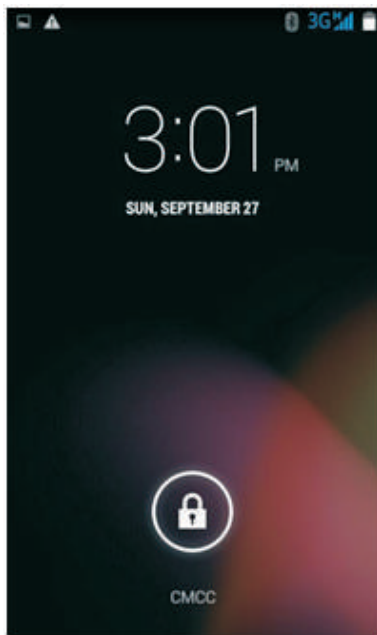
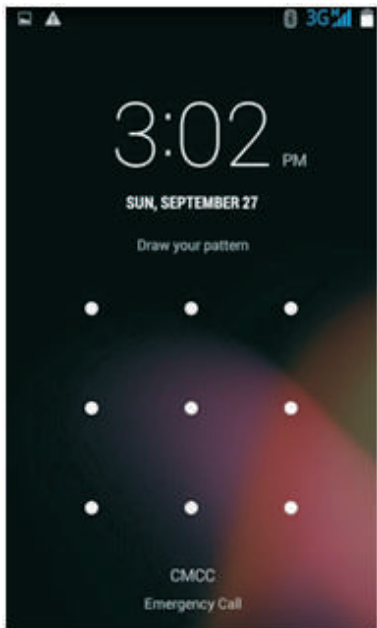

Figure 2-9: PIN Screen



Figure 2-10: Pattern Screen



Resetting the Device

There are two reset functions, soft reset and hard reset.

Performing a Soft Reset

Perform a soft reset if applications stop responding.

Procedure:

- 1、 Press and hold the Power button until the menu appears.
- 2、 Touch Reboot.
- 3、 The device shuts down and then reboots.

Performing a Hard Reset



Caution: Performing a hard reset with a SIM card installed in the MC36 may cause damage or data corruption to the SIM card.

Perform a hard reset if the MC36 stops responding.



Procedure:

- 1、 Simultaneously press the Power, Left side Scan and Volume Up buttons.
- 2、 The MC36 shuts down and then reboots.

Suspend Mode

The MC36 goes into suspend mode when the user presses the Power button or after a period of inactivity (set in the Display settings window).

To wake the MC36 from Suspend mode, press the Power button.

The Lock screen displays. Slide  to the right toward  to unlock the screen. If the Pattern screen unlock feature is enabled, the Pattern screen appears instead of the Lock screen. See Un-Locking the Screen.



Note:

If the user enters the PIN, password or pattern incorrectly five times, they must wait 30 seconds before trying again. If the user forgets the PIN, password or pattern contact the system administrator.

Figure 2-11: Lock Screen

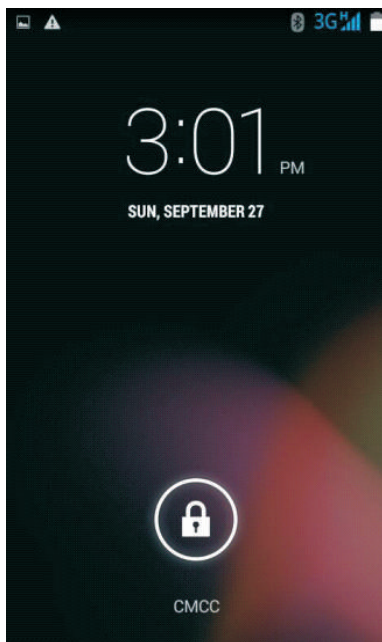

Chapter 3 Applications

This section describes the applications installed on the device.

File Manager

Use the File Manager application to view and manage files on the device.

To open File Manager, touch  > .

Figure 3-1: File Manager Screen

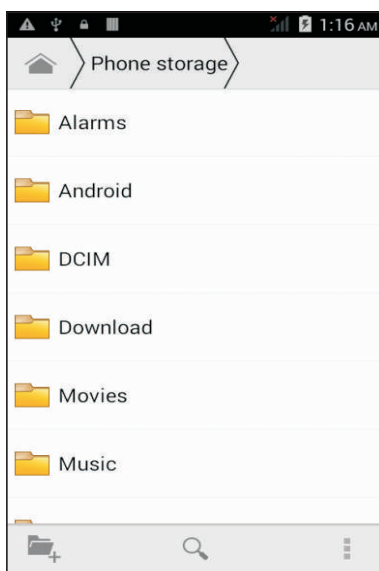

Touch and hold an item to perform an operation on that item. Select one of the options from the File Operations menu:

- Cut - Move the file or folder to a new location.
- Copy - Copy the select file.
- Delete - Delete the selected file.
- Share - Share the file with other devices.
- Touch  to open additional functionality:
 - Rename - Rename the select file.
 - Details - View detailed information about the file or folder.

People

Use the People application to manage contacts.

From a Home or Apps screen, touch . People opens to the main list of contacts. View contacts in three ways at the top of the screen: Groups, All contacts, and Favorites. Touch the tabs to change how to view the contacts.

Swipe up or down to scroll through the lists.



Adding People

Procedure:

- 1、 In the People application, touch .
- 2、 If there are more than one account with contacts, touch the one to use.
- 3、 Type the contact's name and other information. Touch a field to start typing, and swipe down to view all categories.
- 4、 To add more than one entry for a category. For example, to add a work address after typing a personal address and touch Add new for that field. To open a menu with preset labels, such as Home or Work for an email address, touch the label to the right of the item of contact information. Or, to create your own label, touch Custom in the menu.
- 5、 Touch DONE.



Editing People

Procedure:

- 1、 In the People application, touch .
- 2、 Touch a person to edit.
- 3、 Touch .
- 4、 Touch Edit.
- 5、 Edit the contact information.
- 6、 Touch DONE.

Deleting People

Procedure:

- 1、 In the People application, touch .
- 2、 Touch a person to edit.
- 3、 Touch .
- 4、 Touch Delete.
- 5、 Touch OK to confirm.

Camera

This section provides information for taking photos and recording videos using the integrated digital cameras.





Note: If a microSD card is installed, the MC36 saves photos and videos on the microSD card. If a microSD card is not installed, the MC36 saved photos and videos on the internal storage.

Taking Photos

To take a photo:

Procedure:

- 1、 Touch .
- 2、 Touch .
- 3、 Touch . The camera brings the image into focus. When the image is in focus, the focus indicators in each corner turn green, the camera takes a photo and a shutter sound plays.



Note: To disable the shutter sound, turn notification sounds off. Touch  >  Sounds > Volumes and slide the Notifications slider all the way to the left.

- 4、 The photo appears momentarily then displays as a thumbnail in the upper right corner. Touch the thumbnail to view the photo in Gallery. See Gallery for more information.

Taking a Panoramic Photo

Panorama mode lets the user create a single wide image by panning slowly across a scene.







Procedure:

- 1、 Touch .
- 2、 Touch .
- 3、 Touch the options bar and touch .
- 4、 Frame one side of the scene to capture.
- 5、 Touch  and slowly start panning across the area to capture. A small white square appears inside the button the shot is in progress. If panning too quickly, the message too fast appears.
- 6、 Touch  to end the shot. The panorama appears immediately and a progress indicator displays while it saves the image.
- 7、 Touch the thumbnail to view the photo in Gallery.

Recording Videos

To record a video:

Procedure:

- 1、 Touch  >  .
- 2、 Touch the options bar and touch  .
- 3、 Touch  >  to adjust exposure, flash, and other settings using the camera settings.
- 4、 Touch  to start recording. The device starts recording the video. The video time remaining appears in the top left of the screen.
- 5、 Touch  to end recording.



Note: The photo appears momentarily then displays as a thumbnail in the upper right corner.

- 6、 Touch the thumbnail to access the Gallery application.

Gallery



Note:

The device supports the following image formats: jpeg, gif, png and bmp.

The device supports the following video formats: H.263, H.264 and MPEG4 Simple Profile.

Use Gallery to:

- view photos
- play videos
- perform basic editing of photos
- set photos as wallpaper
- set photos as a contact photo
- share photos and videos.



To open the Gallery application, touch  >  or in the camera application touch the thumbnail image at the top right. Gallery presents all photos and videos stored on the microSD card in albums.

Figure 3-2: Gallery — Albums



- Touch an album to open it and view its contents. The photos and videos in the album are displayed in chronological order.
- Touch a photo or video in an album to view it.

Working with Albums

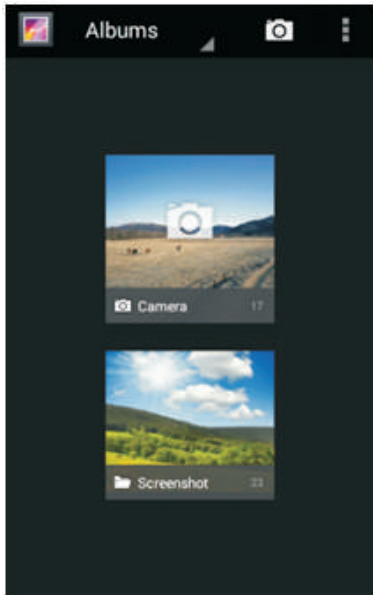
Albums are groups of images and videos in folders. Touch an album to open it. The photos and videos are listed in a chronologically ordered grid. The name of the album displays at the top of the screen.

Figure 3-3: Photos Inside an Album

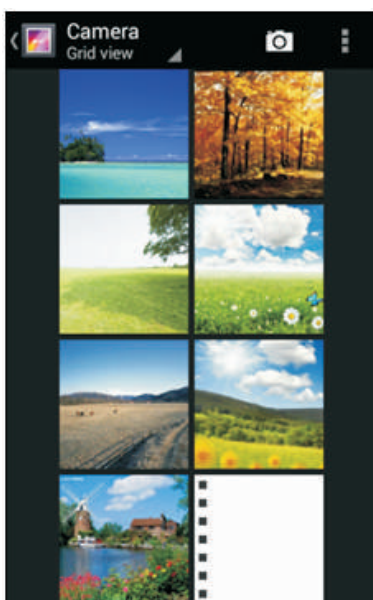

Swipe left or right to scroll images across the screen.



Share an Album

Procedure:

- 1、 Touch  .
- 2、 Touch  .
- 3、 Touch and hold an album until it highlights.
- 4、 Touch other albums as required.
- 5、 Touch  . The Share menu opens. Touch the application to use to share the selected albums.
- 6、 Follow the instructions within the selected application.

Get Album Information



Procedure:

- 1、 Touch  .
- 2、 Touch  .
- 3、 Touch and hold an album until it highlights.
- 4、 Touch  .
- 5、 Touch Details.

Deleting an Album

To delete an album and its contents from the microSD card:

Procedure:

- 1、 Touch  .
- 2、 Touch  .
- 3、 Touch and hold an album until it highlights.
- 4、 Check other albums to delete. Ensure that other albums are selected.
- 5、 Touch Delete. In the Delete selected item? Menu, touch OK to delete the album.

Working with Photos

Use Gallery to view photos on the microSD card and edit and share photos.

Viewing and Browsing Photos

To view a photo:

Procedure:



- 1、 Touch  .
- 2、 Touch  .
- 3、 Touch an album to open it.
- 4、 Touch a photo.



Figure 3-4: Photo Example



- 5、 Swipe left or right to view the next or previous photo in the album.
- 6、 Turn the device to view the photo in upright (portrait) or sideways (landscape) orientation. The photo is displayed (but not saved) in the new orientation.
- 7、 Touch the photo to view the controls
- 8、 Double-tap the screen to zoom in or pinch two fingers together or spread them apart to zoom in or out.
- 9、 Drag the photo to view parts that are not in view.

Rotating a Photo

Procedure:

- 1、 Touch a photo to view the controls.
- 2、 Touch  .
- 3、 Touch Edit.
- 4、 Touch  .
- 5、 Touch Rotate.
- 6、 Touch Save, the photo is saved with the new orientation.

Cropping a Photo

Procedure:

- 1、 In Gallery, touch a photo to view the controls.
- 2、 Touch  .
- 3、 Touch Crop. The cropping tool appears.
- 4、 Use the cropping tool to select the portion of the photo to crop.
 - Drag from the inside of the cropping tool to move it.
 - Drag an edge of the cropping tool to resize it to any proportion.
 - Drag a corner of the cropping tool to resize it with fixed proportions.



Figure 3-5: Cropping Tool



- 5、 Touch Save to save a copy of the cropped photo. The original version is retained.



Setting a Photo as a Contact Icon

Procedure:

- 1、 Touch .
- 2、 Touch .
- 3、 Touch an album to open it.
- 4、 Touch a photo to open it.
- 5、 Touch .
- 6、 Touch Set picture as.
- 7、 Touch Contact photo.
- 8、 In the People application, touch a contact.
- 9、 Touch the blue box and crop the photo accordingly.
- 10、 Touch Save.

Get Photo Information

Procedure:

- 1、 Touch .
- 2、 Touch .
- 3、 Touch an album to open it.
- 4、 Touch a photo to open it.
- 5、 Touch .
- 6、 Touch Details.
- 7、 Touch Close.



Share a Photo

Procedure:

- 1、 Touch  .
- 2、 Touch  .
- 3、 Touch an album to open it.
- 4、 Touch a photo to open it.
- 5、 Touch  .
- 6、 Touch the application to use to share the selected photo. The application selected opens with the photo attached to a new message.

Deleting a Photo

Procedure:

- 1、 Touch  .
- 2、 Touch  .
- 3、 Touch an album to open it.
- 4、 Touch a photo to open it.
- 5、 Touch Delete.
- 6、 In the Delete selected item? Menu, touch OK to delete the photo.

Working with Videos

Use Gallery to view videos on the microSD card and share videos.

Procedure:





- 1、 Touch  .
- 2、 Touch  .
- 3、 Touch an album to open it.
- 4、 Touch a video.



Figure 3-6: Video Example

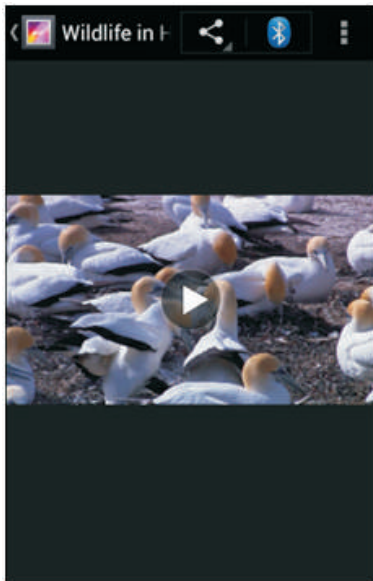

- 5、 Touch  . The video begins to play.
- 6、 Touch the screen to view the playback controls.



Sharing a Video

Procedure:

- 1、 Touch  .
- 2、 Touch  .
- 3、 Touch an album to open it.
- 4、 Touch a video to open it.
- 5、 Touch  . The Share menu appears.
- 6、 Touch the application to use to share the selected video. The application selected opens with the video attached to a new message.

Deleting a Video

Procedure:

- 1、 Touch  .
- 2、 Touch  .
- 3、 Touch an album to open it.
- 4、 Touch a video to open it.
- 5、 Touch Delete.
- 6、 In the Delete selected item? Menu, touch OK to delete the video.

Movie Studio

Movie Studio is a video editing application. Capture or upload videos or photos and Movie Studio automatically turns them into beautifully edited movies, complete with music and effects. Key features include:

- Select video, photo and music files from the device.
- Trim and edit video clips.
- Delete the middle part from a video.
- Split a video file into several separate clips.
- Adding video effects (fade in, fade out, gray tone, negative, slow-motion).
- Add and edit the background music for the movie.
- Add multiple pictures as slide show movies.

Figure 3-7: Movie Studio Application

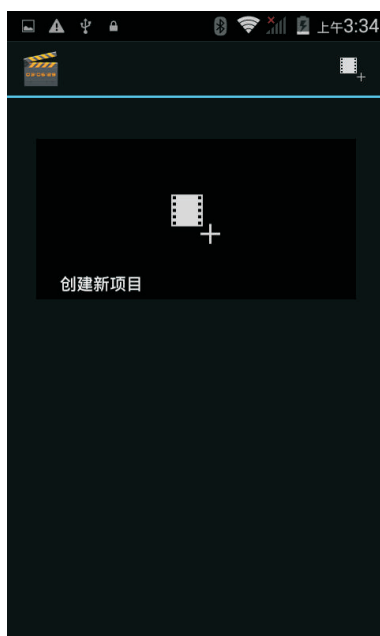

ScanDemo

Use ScanDemo to demonstrate data capture functionality.

Figure 3-8: ScanDemo Demonstration Window

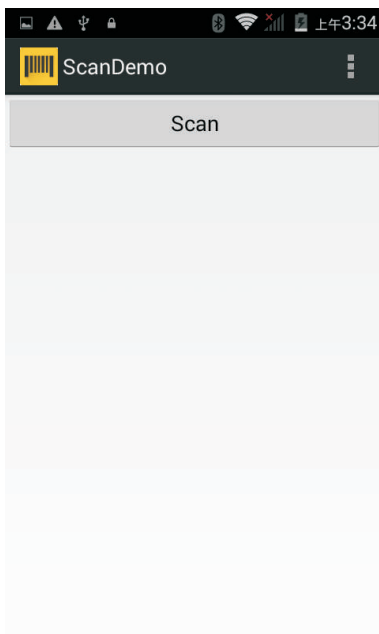

Press the yellow scan button to enable data capture. The captured data appears in the text field below the yellow button.

Sound Recorder

Use Sound Recorder to record audio messages.

Recordings are saved on the microSD card (if installed) or the Internal Storage and available in the Music application playlist titled "My Recordings."

Figure 3-9: Sound Recorder Application

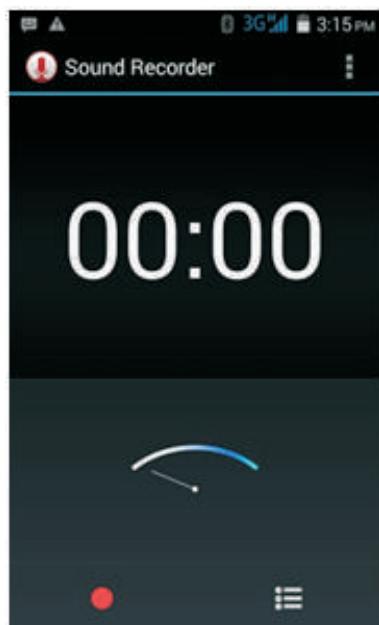

Chapter 4 Data Capture

The MC36 offers the following data capture options:

- integrated linear imager



Note: ScanDemo is installed and enabled on the MC36 by default.

Linear Imager

The device with an integrated linear imager has the following features:

- Reading a variety of bar code symbologies, including the most popular 1-D code types.
- Intuitive aiming for easy point-and-shoot operation.

The imager uses digital camera technology to take a digital picture of a bar code, stores the resulting image in its memory, and executes state-of-the-art software decoding algorithms to extract the data from the image.

Scanning Considerations

Typically, scanning is a simple matter of aim, scan, and decode where a few quick trial efforts master it. However, consider the following to optimize scanning performance:

- Range

–Any scanning device decodes well over a particular working range — minimum and maximum distances from the bar code. This range varies according to bar code density and scanning device optics.

–Scanning within range brings quick and constant decodes; scanning too close or too far away prevents decodes.

Move the scanner closer and farther away to find the right working range for the bar codes being scanned.

- Angle

–Scan angle is important for promoting quick decodes. When laser beams reflect directly back into the scanner from

the bar code, this specular reflection can “blind” the scanner.

-To avoid this, scan the bar code so that the beam does not bounce directly back. But do not scan at too sharp an angle; the scanner needs to collect scattered reflections from the scan to make a successful decode. Practice quickly shows what tolerances to work within.

- Hold the device farther away for larger symbols.
- Move the device closer for symbols with bars that are close together.



Note: Scanning procedures depend on the application and device configuration. An application may use different scanning procedures from those described.

Bar Code Capture with Linear Imager or 2D Imager

To capture bar code data:

Procedure:

- 1、 Ensure that an application is open on the MC36 and a text field is in focus (text cursor in text field).
- 2、 Point the top of the MC36 at a bar code.

Figure 4-1: Scanning

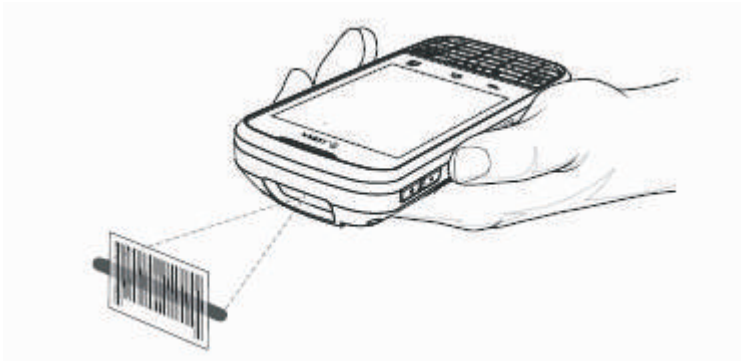

- 3、 Press and hold the scan button. The LED lights red to indicate that data capture is in process.
- 4、 Place the red aiming pattern across the bar code. The LED lights green and a beep sounds, by default, to indicate the bar code was decoded successfully.

Figure 4-2: Aiming Pattern



- 5、 The captured data appears in the text field.

Chapter 5 Wireless

This section provides information on the wireless features:

- Wireless Wide Area Network (WWAN)
- Wireless Local Area Network (WLAN)
- Bluetooth
- HF-RFID

Wireless Wide Area Networks

Use Wireless wide area networks (WWANs) to access data over a cellular network. This section provides information on:

- Sharing s data connection
- Disabling data roaming
- Monitoring data usage
- Limiting connections to 2G networks
- Locking a SIM card
- Editing Access Point Names (APNs).

Sharing the Mobile Data Connection

The tethering & portable hotspot settings allow you to share your data connection. You can share the MC36's mobile data connection with a single computer via USB tethering or Bluetooth tethering.

You can also share the data connection with up to eight devices at once, by turning it into a portable Wi-Fi hotspot.

While the MC36 is sharing its data connection, an icon appears at the top of the screen and a corresponding message appears in the notification list.

USB Tethering



Note: USB tethering is not supported on computers running Mac OS. If your computer is running Windows 7 or a recent version of Linux (such as Ubuntu), follow these instructions without any special preparation. If running

a version of Windows that precedes Windows 7, or some other operating system, you may need to prepare the computer to establish a network connection via USB.

Procedure:

- 1、 Connect the MC36 to a host computer with the USB cable.

A USB icon appears at the top of the screen, and the notification Connected as a media device or Connected as a camera appears briefly at the top of the screen.

- 2、 Touch  .
- 3、 Touch  .
- 4、 Touch More...
- 5、 Touch Tethering & portable hotspot.
- 6、 Check USB tethering.

The host computer is now sharing the MC36's data connection.



Post requisites: To stop sharing the data connection, uncheck USB tethering or disconnect the USB cable.

Bluetooth Tethering

Use Bluetooth tethering to share the data connection with a host computer.

Prerequisites: Configure the host computer to obtain its network connection using Bluetooth. For more information, see the host computer's documentation.

Procedure:

- 1、 Pair the MC36 with the host computer.
- 2、 Touch  .
- 3、 Touch  .
- 4、 Touch More....
- 5、 Touch Tethering & portable hotspot
- 6、 Check Bluetooth tethering.

The host computer is now sharing the MC36's data connection.

Post requisites: To stop sharing the data connection, uncheck Bluetooth tethering .

Portable Wi-Fi Hotspot

Prerequisites: Configure the Wi-Fi Hotspot settings.

Procedure:

- 1、 Touch  .
- 2、 Touch  .
- 3、 Touch More....
- 4、 Touch Tethering & portable hotspot.
- 5、 Check Portable Wi-Fi hotspot.

After a moment, the MC36 starts broadcasting its Wi-Fi network name (SSID), so you can connect it with up to eight computers or other devices.

Post requisites: To stop sharing the data connection, uncheck Portable Wi-Fi hotspot.

Configuring the Wi-Fi Hotspot

Procedure:

- 1、 Touch  .
- 2、 Touch  .
- 3、 Touch More...
- 4、 Touch Tethering & portable hotspot.

Figure 5-1: Set up Wi-Fi Hotspot Dialog Box





- 5、 In the Network SSID text field, edit the network name.
- 6、 Touch the Security option and select a security method from the drop-down list.
 - None
 - WPA2 PSK
- 7、 In the Password text field, enter a password.



Note: If None is selected in the Security option, a password is not required.

- 8、 Touch Save.

Data Usage

Data usage refers to the amount of data uploaded or downloaded by the MC36 during a given period. Depending on the wireless plan, you may be charged additional fees when your data usage exceeds your plan's limit. To monitor your data usage, go to  >  Data usage.



Caution: The usage displayed on the data usage settings screen is measured by your device. Your carrier's data usage accounting may differ. Usage in excess of your carrier plan's data limits can result in steep overage charges. The feature described here can help you track your usage, but is not guaranteed to prevent additional charges.

Data usage settings allow you to:

- Set the data usage level at which you'll receive a warning.
- Set a data usage limit.
- View or restrict data usage by app.
- Identify mobile hotspots and restrict background downloads that may result in extra charges.

By default, when you open the data usage settings screen you see the settings for mobile data: that is, the data network or networks provided by your carrier:

Figure 5-2: Data Usage Screen

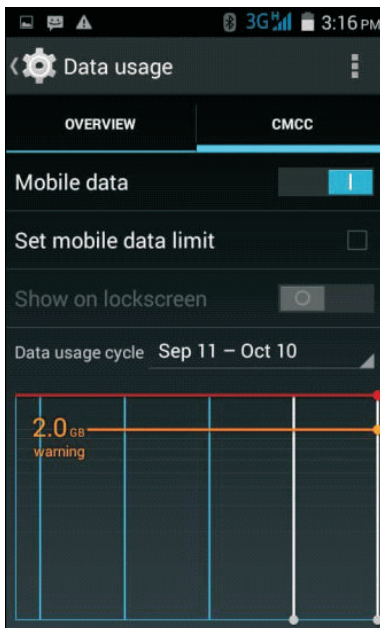

To display Wi-Fi data usage settings in a separate tab touch  > Show Wi-Fi usage.

Just below the on-off switch, note the data usage cycle. Touch it to choose a different cycle. This date range is the period of time for which the graph displays data usage.

The vertical white lines on the graph show a period of time within the data usage cycle. This range determines the usage amount displayed just below the graph. Drag lines to change the period.

Set Data Usage Warning

Drag the orange line by its right side to the level where you want to receive a warning. When your data usage reaches this level, you'll receive a notification.



Set Auto-Sync

You can also conserve data usage by syncing your apps manually, only when you need the data, rather than relying on auto-sync. To turn auto-sync off or on, touch  > Auto-sync data.

Disabling Data When Roaming



To prevent the device from transmitting data over other carriers' mobile networks when leaving an area that is covered by the carrier's networks. This is useful for controlling expenses if the service plan does not include data roaming.

Procedure:

- 1、 Touch  .
- 2、 Touch  .
- 3、 Touch SIM Management .
- 4、 Touch Data roaming.
- 5、 Select which SIM card will be cancel for Data roaming.

Limiting Data Connection to 2G Networks

Procedure:

- 1、 Touch  .
- 2、 Touch  .
- 3、 Touch More....
- 4、 Touch Mobile networks.
- 5、 Touch 3G service.
- 6、 Touch Enable 3G.
- 7、 Select Off to limit Data connection to 2G networks.

SIM Management

Procedure:



- 1、 Touch  .
- 2、 Touch  .
- 3、 Touch SIM management.

Figure 5-3: SIM management Dialog Box



4. If user installs two SIMs in the device, select the default SIM for outgoing calls and SMS messages. System default option is “Always ask” which always pops up a selection menu when making a call or sending out a SMS. If users install one SIM and use it for a while, system default the first SIM to make a call and SMS even when the second SIM is installed.

Figure 5-4: Selection Menu Dialog Box

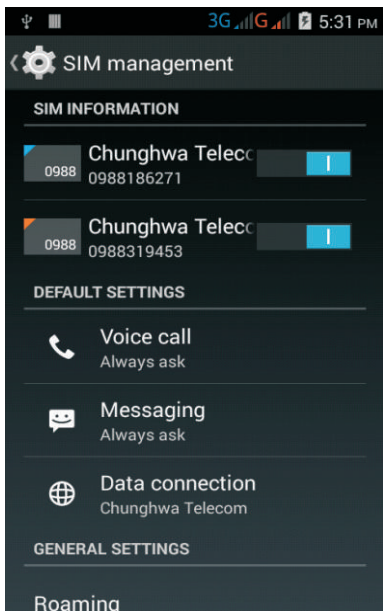
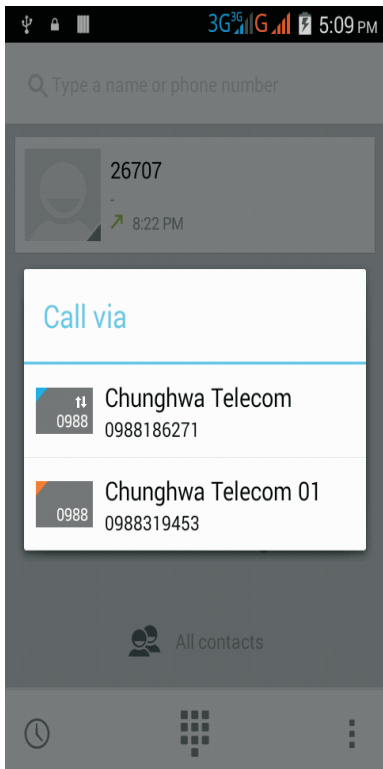

Selecting SIM for 3G Service

Provide 3G capability switch between SIM cards. User do not need to switch SIM card physically.

Procedure:



- 1、 Touch .
- 2、 Touch .
- 3、 Touch More....
- 4、 Touch Mobile networks.
- 5、 Touch 3G service.
- 6、 Touch Enable 3G. The selected SIM will be enable to 3G networks and the unselected is limited to 2G networks.

Figure 5-5: Enable 3G Service Dialog Box



Locking the SIM Card

Locking the SIM card requires the user to enter a PIN every time the MC36 is turned on. If the correct PIN is not entered, only Emergency calls can be made.

Procedure:



- 1、 Touch .
- 2、 Touch .
- 3、 Touch Security.
- 4、 Touch Set up SIM card lock.
- 5、 Touch Lock SIM card.

Figure 5-6: Enter PIN to Lock SIM Card



- 6、 Enter the PIN associated with the card. Touch OK.
- 7、 Reboot the MC36.



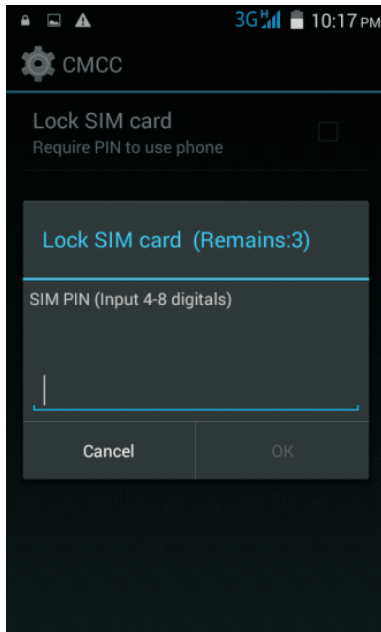

Editing the Access Point Name



Note: Many service provider Access Point Name (APN) data are pre-configured in the MC36. The APN information for all other service providers must be obtained from the wireless service provider.

To use the data on a network the user must configure the APN information.

Procedure:

- 1、 Touch .
- 2、 Touch .
- 3、 Touch More....
- 4、 Touch Mobile networks.
- 5、 Touch Access Point Names.
- 6、 Touch .
- 7、 Touch New APN.
- 8、 Touch each APN settings and enter the appropriate data obtained from the wireless service provider.
- 9、 Touch .
- 10、 Touch Save.
- 11、 Touch the radio button next to the new APN name to start using it.

Wireless Local Area Networks

Wireless local area networks (WLANs) allow the MC36 to communicate wirelessly inside a building. Before using the MC36 on a WLAN, the facility must be set up with the required hardware to run the WLAN (sometimes known as infrastructure). The infrastructure and the MC36 must both be properly configured to enable this communication.

Refer to the documentation provided with the infrastructure (access points (Aps), access ports, switches, Radius servers, etc.) for instructions on how to set up the infrastructure.

Once the infrastructure is set up to enforce the chosen WLAN security scheme, use the Wireless & networks settings to configure the MC36 to match the security scheme.

The MC36 supports the following WLAN security options:

- Wireless Equivalent Privacy (WEP)
- Wi-Fi Protected Access (WPA)/WPA2 Personal (PSK)
- Extensible Authentication Protocol (EAP)
 - Protected Extensible Authentication Protocol (PEAP) - with Microsoft Challenge- Handshake Authentication Protocol version 2 (MSCHAPv2) and Generic Token Card (GTC) authentication.
 - EAP-Transport Layer Security (TLS)
 - EAP-TTLS - with Password Authentication Protocol (PAP), MSCHAP and MSCHAPv2 authentication.
 - SIM
 - AKA

The Status bar displays icons that indicate Wi-Fi network availability and Wi-Fi status. See Status Bar for more information.



Note: Turn off Wi-Fi when not using it, to extend the life of the battery.

Scanning and connect to the WLAN network

Procedure:

1. Touch .
2. Touch .

Figure 5-7: Settings Screen

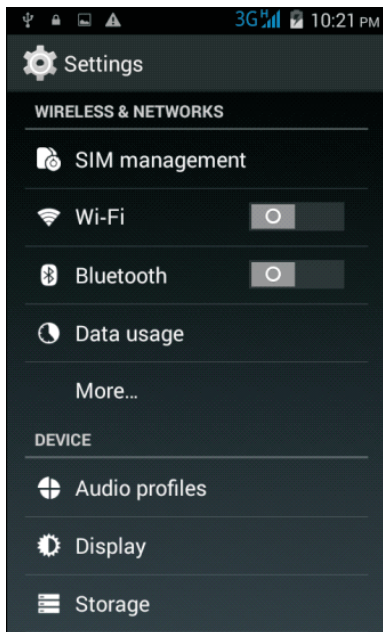

3. Slide the Wi-Fi switch to the ON position.
4. Touch  Wi-Fi. The MC36 searches for WLANs in the area and lists them.

Figure 5-8: Wi-Fi Screen



5. Scroll through the list and select the desired WLAN network.
6. For open networks, touch profile once or press and hold and then select Connect to network or for secure networks enter the required password or other credentials then touch Connect. See the system administrator for more information.

The MC36 obtains a network address and other required information from the network using the dynamic host configuration protocol (DHCP) protocol. To configure the MC36 with a fixed internet protocol (IP) address, See Configuring the Device to Use a Static IP Address.

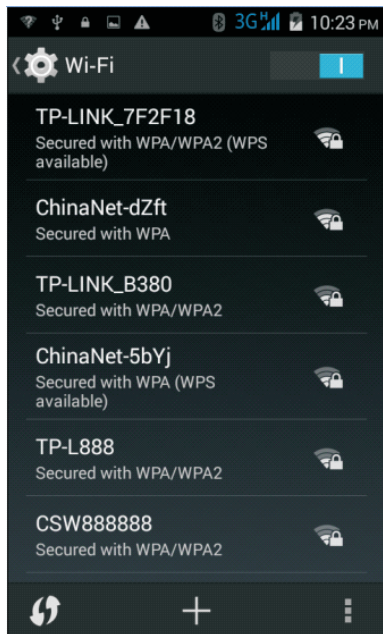
7. In the Wi-Fi setting field, Connected appears indicating that the MC36 is connected to the WLAN.

Configuring a Wi-Fi Network

Procedure:



1. Touch .
2. Touch .
3. Touch  Wi-Fi.
4. Slide the switch to the ON position.
5. The MC36 searches for WLANs in the area and lists them on the screen.
6. Scroll through the list and select the desired WLAN network.
7. Touch the desired network. If the network security is Open, the MC36 automatically connects to the network. For all other network security a dialog box appears.

Figure 5-9: WLAN Network Security Dialog Boxes



Note: By default, the network Proxy is set to None and the IP settings is set to DHCP. See Configuring for a Proxy Server for setting connection to a proxy server and see Configuring the Device to Use a Static IP Address for setting the device to use a static IP address.

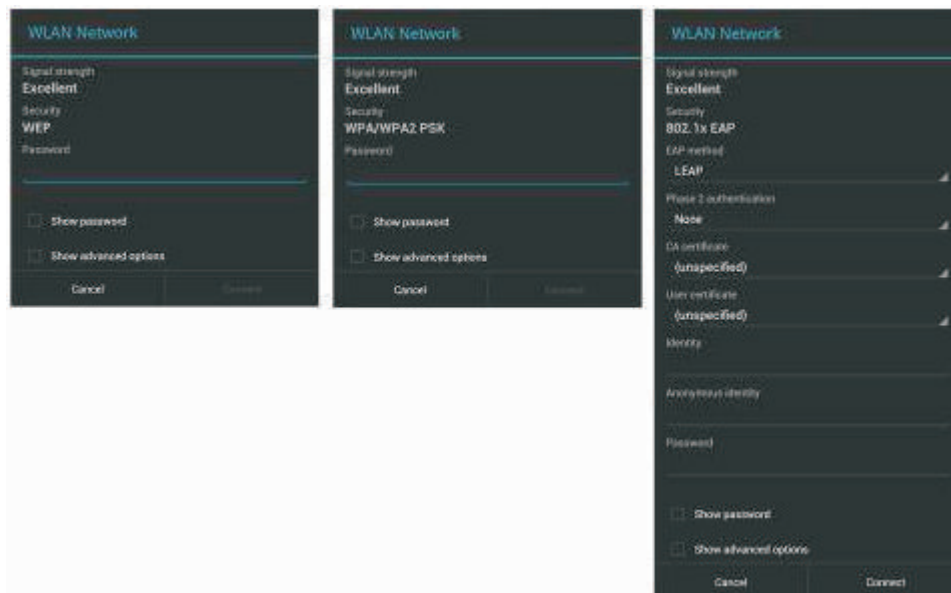

8. If the network security is WEP or WPA/WPA2 PSK, enter the required password and then touch Connect.

- 9、 If the network security is 802.1x EAP, enter the information below and then touch Connect:
 - Touch the EAP method drop-down list and select PEAP, TLS, TTLS or PWD.
 - Touch the Phase 2 authentication drop-down list and select an authentication method.
 - If required, touch CA certificate and select a Certification Authority (CA) certificate.
Note: Certificates are installed using the Security settings.
 - If required, touch User certificate and select a user certificate.
Note: User certificates are installed using the Location & security settings.
 - If required, in the Identity text box, enter the username credentials.
 - If desired, in the Anonymous identity text box, enter an anonymous identity username.
 - If required, in the Password text box, enter the password for then given identity.

Manually Adding a Wi-Fi Network

Manually add a Wi-Fi network if the network does not broadcast its name (SSID) or to add a Wi-Fi network when out of range.

Procedure:

- 1、 Touch  .
- 2、 Touch  .
- 3、 Touch  Wi-Fi.
- 4、 Slide the switch to the ON position.
- 5、 Touch + in the bottom right corner of the screen.
- 6、 In the Network SSID text box, enter the name of the Wi-Fi network.
- 7、 In the Security drop-down list, select the type of security. Options:
 - None
 - WEP
 - WPA/WPA2 PSK
 - 802.1x EAP。
 - WAPI PSK
 - WAPI Certificate
- 8、 If the network security is None, touch Save.
- 9、 If the network security is WEP or WPA/WPA2 PSK, enter the required password and then touch Save.
- 10、 If the network security is 802.1x EAP enter the information below and then touch Save:
 - Touch the EAP method drop-down list and select PEAP, TLS or TTLS.
 - Touch the Phase 2 authentication drop-down list and select an authentication method.
 - If required, touch CA certificate and select a Certification Authority (CA) certificate.
Note: Certificates are installed using the Security settings.
 - If required, touch User certificate and select a user certificate.
Note: User certificates are installed using the Security settings.
 - If required, in the Identity text box, enter the username credentials.

- If desired, in the Anonymous identity text box, enter an anonymous identity username.
- If required, in the Password text box, enter the password for then given identity.

Configuring the Device to Use a Static IP Address

By default, the device is configured to use Dynamic Host Configuration Protocol (DHCP) to assign an Internet protocol (IP) address when connecting to a wireless network. To configure the device to connect to a network using a static IP address:

Procedure:

1. In the network dialog box, touch a network.
2. Touch Show advanced options checkbox.
3. Touch IP settings and select Static.

Figure 5-10: Static IP Settings



4. In the IP address(Ipv4) text box, enter an IP address for the device.
5. If required, in the Gateway text box, enter a gateway address for the device.
6. If required, in the Network prefix length text box, enter a the prefix length.
7. If required, in the DNS 1 text box, enter a Domain Name System (DNS) address.
8. If required, in the DNS 2 text box, enter a DNS address.
9. Touch Save.

Advanced Wi-Fi Settings



Note: Advanced Wi-Fi settings are for the device not for a specific wireless network.

Use the Advanced settings to configure additional Wi-Fi settings. From the Wi-Fi screen, touch  > Advanced to view the advanced settings.

Figure 5-11: Advanced Wi-Fi Options



Network notification - When enabled, notifies the user when an open network is available.

Keep Wi-Fi on during sleep – Opens a menu to set whether and when the Wi-Fi radio turns off.

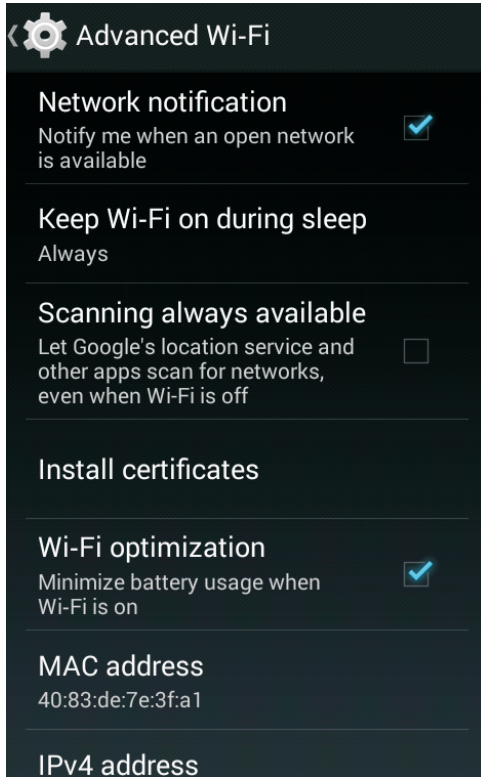
- Always (increases data usage) - The radio stays on when the device enters suspend mode.
- Only when plugged in - The radio stays on while the device is connected to external power.
- Never - The radio turns off when the device enters suspend mode (default).

Install certificates – Opens a menu to set which certificate to install.

WLAN optimization – Minimize battery usage when Wi-Fi is on.

MAC address - Displays the Media Access Control (MAC) address of the device when connecting to Wi-Fi networks.

Ipv4 address - Displays the IP address of the device when connecting to Wi-Fi networks.

Modifying a Wi-Fi Network

The user can change settings and passwords for a network in the Wi-Fi list.

Procedure:



- 1、 Touch .
- 2、 Touch .

- 3、 Touch  Wi-Fi.
- 4、 Slide the switch to the ON position.
- 5、 Touch and hold on a network name and then touch Modify networks.
- 6、 Modify the network settings and then touch Save.

Remove a Wi-Fi Network

To remove a remembered or connected network:

Procedure:

- 1、 Touch  .
- 2、 Touch  .
- 3、 Touch  Wi-Fi.
- 4、 In the Wi-Fi networks list, touch and hold the name of the network.
- 5、 In the menu, touch Forget network.

Bluetooth

Bluetooth-equipped devices can communicate without wires, using frequency-hopping spread spectrum (FHSS) radio frequency (RF) to transmit and receive data in the 2.4 GHz Industry Scientific and Medical (ISM) band (802.15.1). Bluetooth wireless technology is specifically designed for short-range (10 meters (32.8 feet)) communication and low power consumption.

Devices with Bluetooth capabilities can exchange information (e.g. files, appointments, and tasks) with other Bluetooth enabled devices such as printers, access points, and other mobile devices.

Adaptive Frequency Hopping

Adaptive Frequency Hopping (AFH) is a method of avoiding fixed frequency interferers, and can be used with Bluetooth voice. All devices in the piconet (Bluetooth network) must be AFH-capable in order for AFH to work. There is no AFH when connecting and discovering devices. Avoid making Bluetooth connections and discoveries during critical 802.11b communications. AFH for Bluetooth consists of four main sections:

- Channel Classification - A method of detecting an interference on a channel-by-channel basis, or pre-defined channel mask.
- Link Management - Coordinates and distributes the AFH information to the rest of the Bluetooth network.
- Hop Sequence Modification - Avoids interference by selectively reducing the number of hopping channels.
- Channel Maintenance - A method for periodically re-evaluating the channels.

When AFH is enabled, the Bluetooth radio “hops around” (instead of through) the 802.11b high-rate channels. AFH coexistence allows Motorola Enterprise Tablets to operate in any infrastructure.

The Bluetooth radio in this device operates as a Class 2 device power class. The maximum output power is 2.5 mW and the expected range is 10 meters (32.8 ft.). A definition of ranges based on power class is difficult to obtain due to power and device differences, and whether one measures open space or closed office space.



Note: It is not recommended to perform Bluetooth wireless technology inquiry when high rate 802.11b operation is required.

Security

The current Bluetooth specification defines security at the link level. Application-level security is not specified. This allows application developers to define security mechanisms tailored to their specific need. Link-level security occurs between devices, not users, while application-level security can be implemented on a per-user basis. The Bluetooth specification defines security algorithms and procedures required to authenticate devices, and if needed, encrypt the data flowing on the link between the devices. Device authentication is a mandatory feature of Bluetooth while link encryption is optional.

Pairing of Bluetooth devices is accomplished by creating an initialization key used to authenticate the devices and create a link key for them. Entering a common personal identification number (PIN) in the devices being paired generates the initialization key. The PIN is never sent over the air. By default, the Bluetooth stack responds with no key when a key is requested (it is up to user to respond to the key request event). Authentication of Bluetooth devices is based-upon a challenge-response transaction. Bluetooth allows for a PIN or passkey used to create other 128-bit keys used for security and encryption. The encryption key is derived from the link key used to authenticate the pairing devices. Also worthy of note is the limited range and fast frequency hopping of the Bluetooth radios that makes long-distance eavesdropping difficult.

Recommendations are:

- Perform pairing in a secure environment
- Keep PIN codes private and do not store the PIN codes in the device
- Implement application-level security.

Bluetooth Profiles

The device supports the following Bluetooth services:

- Generic Access Profile (GAP) - Use for device discovery and authentication.
- Service Discovery Protocol (SDP) - Handles the search for known and specific services as well as general services.
- Serial Port Profile (SPP) - Sets up a virtual serial port and connects two Bluetooth enabled devices. For example, connecting the MC36 to a printer.
- Human Interface Device Profile (HID) - Allows Bluetooth keyboards, pointing devices, gaming devices and remote monitoring devices to connect to the MC36.
- Object Push Profile (OPP) - Allows the MC36 to push and pull objects to and from a push server.
- Dial-up Networking (DUN) - Allows the MC36 to access the Internet and other dial-up services using a Bluetooth enabled mobile phone.
- Hands-Free Profile (HFP) - Allows a hands-free device, such as a Bluetooth headset, to place and receive calls on the MC36.
- Advanced Audio Distribution Profile (A2DP) - Allows the MC36 to stream stereo-quality audio to a wireless headset or wireless stereo speakers.

Bluetooth Power States

The Bluetooth radio is off by default.

- Suspend - When the Bluetooth radio turns on and goes into suspend mode, the Bluetooth radio stays on.
- Airplane Mode - When the MC36 is placed in Airplane Mode, the Bluetooth radio turns off. When Airplane mode is disabled, the Bluetooth radio returns to the prior state. When in Airplane Mode, the Bluetooth radio can be turned back on if desired.

Bluetooth Radio Power

Turn off the Bluetooth radio to save power or if entering an area with radio restrictions (e.g., an airplane). When the radio is off, other Bluetooth devices cannot see or connect to the device. Turn on the Bluetooth radio to exchange information with other Bluetooth devices (within range). Communicate only with Bluetooth radios in close proximity.



Note: To achieve the best battery life turn off radios when not in use.

Enabling Bluetooth

Procedure:

- 1、 Touch .
- 2、 Touch .
- 3、 Slide the Bluetooth switch to the ON position.  also appears in the Status bar.
- 4、 Touch .

Disabling Bluetooth

Procedure:

- 1、 Touch .
- 2、 Touch .
- 3、 Slide the Bluetooth switch to the OFF position.  also appears in the Status bar.
- 4、 Touch .

Discovering Bluetooth Device(s)

The MC36 can receive information from discovered devices without pairing. However, once paired, the MC36 and a paired device exchange information automatically when the Bluetooth radio is on. To find Bluetooth devices in the area:

Procedure:



- 1、 Ensure that Bluetooth is enabled on both devices.
- 2、 Ensure that the Bluetooth device to discover is in discoverable mode.
- 3、 Ensure that the two devices are within 10 meters (32.8 feet) of one another.
- 4、 Touch .
- 5、 Touch .
- 6、 Touch  Bluetooth.
- 7、 Touch SEARCH FOR DEVICES. The MC36 begins searching for discoverable Bluetooth devices in the area and displays them under AVAILABLE DEVICES.
- 8、 Scroll through the list and select a device. The Bluetooth pairing request dialog box appears.

Figure 5-12: Bluetooth Pairing - Enter PIN

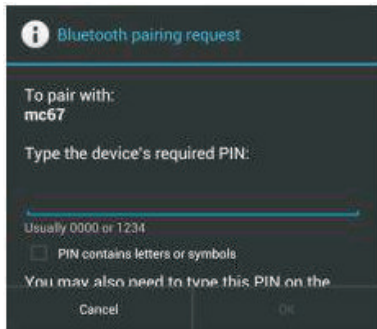
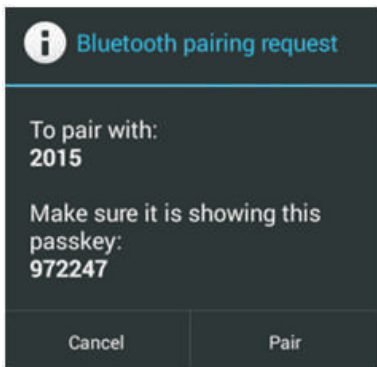

Figure 5-13: Bluetooth Pairing - Smart Pairing







- 9、 Enter a PIN in the text box and touch OK. Enter the same PIN on the other device.
- 10、 For Simple Pairing, touch Pair on both devices.
- 11、 The Bluetooth device is added to the Bluetooth devices list and a trusted (“paired”) connection is established.

Changing the Bluetooth Name

By default, the MC36 has a generic Bluetooth name that is visible to other devices when connected.



Procedure:

- 1、 Touch .
- 2、 Touch .
- 3、 Touch  Bluetooth.
- 4、 If Bluetooth is not on, slide the switch to the ON position.
- 5、 Touch .
- 6、 Touch Rename device.
- 7、 Enter a name and touch OK.

Connecting to a Bluetooth Device

Once paired, connect to a Bluetooth device.

Procedure:

- 1、 Touch .
- 2、 Touch .
- 3、 Touch  Bluetooth.
- 4、 If Bluetooth is not on, slide the switch to the ON position.
- 5、 In the PAIRED DEVICES list, touch and hold on a unconnected Bluetooth device until a menu appears.
- 6、 Touch Connect. When connected, the device is displayed as connected in the list.

Selecting Profiles on the Bluetooth Device

Some Bluetooth devices have multiple profiles. To select a profile:

Procedure:

- 1、 Touch .
- 2、 Touch .
- 3、 Touch  Bluetooth.
- 4、 In the PAIRED DEVICES list, touch  next to the device name.
- 5、 Under PROFILES, check or uncheck a profile to allow the device to use that profile.
- 6、 Touch .

Unpairing a Bluetooth Device

To unpair a Bluetooth device and erase all pairing information:



Procedure:

- 1、 Touch .
- 2、 Touch .
- 3、 Touch  Bluetooth.
- 4、 In the PAIRED DEVICES list, touch  next to the device name.
- 5、 Touch Unpair.
- 6、 Touch .

Bluetooth device(s) can find MC36

The MC36 can be found by discovered devices without pairing. However, once paired, the MC36 and a paired device exchange information automatically when the Bluetooth radio is on. Bluetooth devices find MC36 in the area:

Procedure:

- 1、 Ensure that Bluetooth is enabled on both devices.
- 2、 Ensure that the MC36 to discover is in discoverable mode.
- 3、 Ensure that the two devices are within 10 meters (32.8 feet) of one another.
- 4、 Touch .
- 5、 Touch .
- 6、 Touch  Bluetooth.
- 7、 Touch SEARCH FOR DEVICES. The Bluetooth devices begin searching for discoverable MC36 in the area and displays them under AVAILABLE DEVICES.
- 8、 Scroll through the list and select MC36. The Bluetooth pairing request dialog box appears.
- 9、 Enter a PIN in the text box and touch OK. Enter the same PIN on the MC36.
- 10、 For Simple Pairing, touch Pair on both devices.

The MC36 is added to the Bluetooth devices list and a trusted (“paired”) connection is established.

Chapter 6 Accessories

This chapter provides information for using the accessories for the device.

MC36 Accessories

Table 6-1: MC36 Accessories lists the accessories available for the MC36.

Table 6-1: MC36 Accessories

Accessory	Part Number	Description
Single Slot Charge Only Cradle	CRD-MC36-1SLOT-01	Provides charging for only one MC36 device. Requires additional power supply.
Power Supply(5.4 VDC, 3A)	PWRS-14000-249R	Provides power to the Single Slot Charge Only Cradle.
Power Supply (5VDC, 1.2 A)	PWRS-124306-01CN	Provides power to the MC36.
Auto Charge Cable	VCA400-01R	Charges the MC36 in a Vehicle Cradle using a vehicle's cigarette
AC Line Cord	50-16000-182R	Provides USB communication with a host computer.
Micro USB Cable	CBL-MC36-USB1-01	Provides power to the power supplies. Purchase separately.
Spare 2940 mAh lithium-ion battery	BTRY-TC55-29MA1-01	Replacement 2940 mAh battery.
Spare 4410 mAh lithium-ion battery	BTRY-TC55-44MA1-01	Replacement 4410 mAh battery.
2940 mAh Battery Door	KT-MC36-29BTYD1-01	Replacement battery door for 2940 mAh battery.
4410 mAh Battery Door	KT-MC36-44BTYD1-01	Replacement battery door for 4410 mAh battery.
Hand strap	SG-MC36-HSTRP1-01	Help user easy to hold MC36.

Micro USB Cable

Use the Micro USB Cable to provide USB communication with a host computer.

When the MC36 is connected to a host computer using the Micro USB Cable, the MC36 appears as a Removable Disk on the host computer.



Note: The preferred method to charge the MC36 is to use the Single Slot Charge Cradle.

Single Slot Charge Only Cradle

Figure 6-1: Single Slot Charge Only Cradle Setup

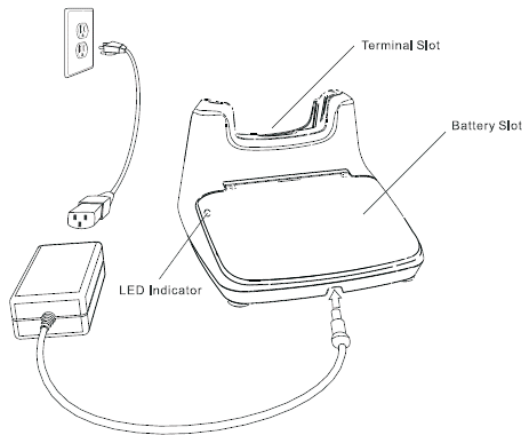

- Provides 5 VDC power for operating the MC36.
- Simultaneously charges up to one MC36.
- Consists of a cradle base and optional cup.

Charging the MC36

1. To charge the MC36, insert the MC36 into the terminal slot.

Figure 6-2: Charging the MC36



- MC36 starts to charge automatically. The 2,940 mAh battery charges in approximately three hours and the 4,410 mAh battery charges in approximately 4.5 hours.

Table 6-2: MC36 Charging Status

LED	Description
Slow Flashing Green	MC36 is charging.
Solid Red	Battery is in an extremely low power state(normal slow charging mode)
Solid Green	MC36 is fully charged.
Fast Flashing Red	Charging error.
Off	Not charging.

Spare Battery Charging

Procedure:

- Lift the battery slot cover.
- Place the battery into battery slot. Ensure that the three tabs on the bottom of battery aligned with the three slots in the battery slot.
- Press the battery down until it locks into place. Close the battery slot cover.
- Starts to charge automatically.

Table 6-3: Battery Charging Status

LED	Description
Solid Red	MC36 is charging
Solid Green	MC36 is fully charged
Flashing Red	Charging error

Charge batteries in temperatures from 0 °C to 40 °C (32 °F to 104 °F). Charging is intelligently controlled by the charger in order to ensure safe operation and optimize long-term battery life. To accomplish this, for small periods of time, the charger alternately enables and disables battery charging to keep the battery at acceptable temperatures. The charger indicates when charging is disabled due to abnormal temperatures via the LED

Chapter 7

Maintenance and Troubleshooting

This chapter includes instructions on cleaning and storing the device, and provides troubleshooting solutions for potential problems during operation.

Maintaining the MC36

For trouble-free service, observe the following tips when using the MC36:

- Do not scratch the screen of the MC36. When working with the MC36, use a finger, glove or pen intended for use with a capacitive touch-sensitive screen. Never use an actual pen or pencil or other sharp object on the surface of the MC36 screen.
- The touch-sensitive screen of the MC36 is glass. Do not drop the MC36 or subject it to strong impact.
- Protect the MC36 from temperature extremes. Do not leave it on the dashboard of a car on a hot day, and keep it away from heat sources.
- Do not store or use the MC36 in any location that is dusty, damp, or wet.
- Use a soft lens cloth to clean the MC36. If the surface of the MC36 screen becomes soiled, clean it with a soft cloth moistened with isopropyl alcohol.
- Periodically replace the rechargeable battery to ensure maximum battery life and product performance. Battery life depends on individual usage patterns.

Battery Safety Guidelines

- The area in which the units are charged should be clear of debris and combustible materials or chemicals. Particular care should be taken where the device is charged in a non commercial environment.
- Follow battery usage, storage, and charging guidelines found in this guide.
- Improper battery use may result in a fire, explosion, or other hazard.
- To charge the mobile device battery, the battery and charger temperatures must be between 0 °C and +45 °C (+32 °F and +113 °F)

- Do not use incompatible batteries and chargers. Use of an incompatible battery or charger may present a risk of fire, explosion, leakage, or other hazard. If you have any questions about the compatibility of a battery or a charger, contact Zebra Global Customer Support Center.
- For devices that utilize a USB port as a charging source, the device shall only be connected to products that bear the USB-IF logo or have completed the USB-IF compliance program.
- Do not disassemble or open, crush, bend or deform, puncture, or shred.
- Severe impact from dropping any battery-operated device on a hard surface could cause the battery to overheat.
- Do not short circuit a battery or allow metallic or conductive objects to contact the battery terminals.
- Do not modify or remanufacture, attempt to insert foreign objects into the battery, immerse or expose to water or other liquids, or expose to fire, explosion, or other hazard.
- Do not leave or store the equipment in or near areas that might get very hot, such as in a parked vehicle or near a radiator or other heat source. Do not place battery into a microwave oven or dryer.
- Battery usage by children should be supervised.
- Please follow local regulations to properly dispose of used re-chargeable batteries.
- Do not dispose of batteries in fire.
- In the event of a battery leak, do not allow the liquid to come in contact with the skin or eyes. If contact has been made, wash the affected area with large amounts of water and seek medical advice.
- If you suspect damage to your equipment or battery, contact Zebra Global Customer Support Center to arrange for inspection.

Cleaning Instructions

**Caution:**

Always wear eye protection.

Read warning label on compressed air and alcohol product before using.

If you have to use any other solution for medical reasons please contact Zebra for more information.



Warning: Avoid exposing this product to contact with hot oil or other flammable liquids. If such exposure occurs, unplug the device and clean the product immediately in accordance with these guidelines.

Approved Cleanser Active Ingredients

100% of the active ingredients in any cleaner must consist of one or some combination of the following: isopropyl alcohol, or mild dish soap.

Harmful Ingredients

The following chemicals are known to damage the plastics on the device and should not come in contact with the device: ammonia solutions, compounds of amines or ammonia; acetone; ketones; ethers; aromatic and chlorinated hydrocarbons; aqueous or alcoholic alkaline solutions; ethanalamine; toluene; trichloroethylene; benzene; carbolic acid and TB-lysoform.

Cleaning Instructions

Do not apply liquid directly to the device. Dampen a soft cloth or use pre-moistened wipes. Do not wrap the device in the cloth or wipe, but gently wipe the unit. Be careful not to let liquid pool around the display window or other places. Allow the unit to air dry before use.

Special Cleaning Notes

Many vinyl gloves contain phthalate additives, which are often not recommended for medical use and are known to be harmful to the housing of the device. The device should not be handled while wearing vinyl gloves containing phthalates, or before hands are washed to remove contaminant residue after gloves are removed. If products containing any of the harmful ingredients listed above are used prior to handling the device, such as hand sanitizer that contain ethanolamine, hands must be completely dry before handling the device to prevent damage to the plastics.

Cleaning Materials Required

- Alcohol wipes
- Lens tissue
- Cotton-tipped applicators
- Isopropyl alcohol
- Can of compressed air with a tube.

Cleaning Frequency

The cleaning frequency is up to the customer's discretion due to the varied environments in which the mobile devices are used. They may be cleaned as frequently as required, but it is advisable to clean the camera window periodically when used in dirty environments to ensure optimum performance.

Cleaning the MC36

- Housing
Using the alcohol wipes, wipe the housing including buttons.
- Display
The display can be wiped down with the alcohol wipes, but care should be taken not to allow any pooling of liquid around the edges of the display. Immediately dry the display with a soft, non-abrasive cloth to prevent streaking.
- Camera and Exit Window
Wipe the camera and exit window periodically with a lens tissue or other material suitable for cleaning optical material such as eyeglasses.

Connector Cleaning

To clean the connectors:

Procedure:

- 1、 Remove the main battery from mobile computer.
- 2、 Dip the cotton portion of the cotton-tipped applicator in isopropyl alcohol.
- 3、 Rub the cotton portion of the cotton-tipped applicator back-and-forth across the connector. Do not leave any cotton residue on the connector.
- 4、 Repeat at least three times.
- 5、 Use the cotton-tipped applicator dipped in alcohol to remove any grease and dirt near the connector area.
- 6、 Use a dry cotton-tipped applicator and repeat steps 4 through 6.



Caution: Do not point nozzle at yourself and others, ensure the nozzle or tube is away from your face.

- 7、 Spray compressed air on the connector area by pointing the tube/nozzle about ½ inch away from the surface.
- 8、 Inspect the area for any grease or dirt, repeat if required

Cleaning Cradle Connectors

To clean the connectors on a cradle:

Procedure:

- 1、 Remove the DC power cable from the cradle.
- 2、 Dip the cotton portion of the cotton-tipped applicator in isopropyl alcohol.
- 3、 Rub the cotton portion of the cotton-tipped applicator along the pins of the connector. Slowly move the applicator back-and-forth from one side of the connector to the other. Do not leave any cotton residue on the connector.
- 4、 All sides of the connector should also be rubbed with the cotton-tipped applicator.



Caution: Do not point nozzle at yourself and others, ensure the nozzle or tube is pointed away from your face.

- 5、 Spray compressed air in the connector area by pointing the tube/nozzle about ½ inch away from the surface.
- 6、 Remove any lint left by the cotton-tipped applicator.
- 7、 If grease and other dirt can be found on other areas of the cradle, use a lint-free cloth and alcohol to remove.
- 8、 Allow at least 10 to 30 minutes (depending on ambient temperature and humidity) for the alcohol to air dry before applying power to cradle.
- 9、 If the temperature is low and humidity is high, longer drying time is required. Warm temperature and dry humidity requires less drying time.



Troubleshooting

The following tables provides typical problems that might arise and the solution for correcting the problem.

Table 7-1: Troubleshooting the MC36

Problem	Cause	Solution
When the user presses the Power button, the MC36 does not turn on.	Battery is completely discharged.	Re-charge or replace the battery.
	Battery not installed properly.	Install the battery properly. See Installing the Battery.
	Power button not held down long enough.	Press the Power button until the LED lights green.
	MC36 not responding.	Perform a hard reset. See Resetting the MC36.
When the user presses the Power button the MC36 does not turn on but a charge battery icon appears on the screen.	Battery charge level is very low.	Re-charge or replace the battery.
After connecting the MC36 to the Charge Cable or Single Slot Charge Cradle, a battery charging icon appears on the screen.	Battery is depleted but is charging.	Press and hold the Power button to turn on the MC36.
When charging, the LED is solid red.	The MC36 is at an extremely low power state.	Charge the MC36 for a few minutes. The LED will change to flashing green then press the Power button to turn on the MC36. If LED continuously blinks red, check power connections. Disconnect and reconnect connections.

Problem	Cause	Solution
Battery did not charge.	Battery failed.	Replace battery. If the MC36 still does not operate, perform a hardware reset.
	MC36 was removed from power while battery was charging.	Insert MC36 in cradle or attach Charge Cable. The 2940 mAh battery fully charges in approximately three hours and the 4410 mAh battery charges in approximately 4.5 hours.
	Extreme battery temperature.	Battery does not charge if ambient temperature is below 0 °C (32 °F) or above 40 °C (104 °F).
During data communication with a host computer, no data transmitted, or transmitted data was incomplete.	MC36 removed from USB cable or disconnected from host computer during communication.	Reattach the communication cable and re-transmit.
During data communication over Wi-Fi, no data transmitted, or transmitted data was incomplete.	Wi-Fi radio is not on.	Turn on the Wi-Fi radio.
	You moved out of range of an access point.	Move closed to an access point.
During data communication over Bluetooth, no data transmitted, or transmitted data was incomplete.	Bluetooth radio is not on.	Turn on the Bluetooth radio.
	You moved out of range of another Bluetooth device.	Move within 10 m (32.8 ft.) of the other device.
During data communication over WAN, no data transmitted, or transmitted data was incomplete.	You are in an area of poor cellular service.	Move into an area that has better service.
	APN is not set up correctly.	See system administrator for APN setup information.
	SIM card not installed properly.	Remove and re-install the SIM card. See Installing the SIM Card.
	Data plan not activated.	Contact your service provider and ensure that your data plan is enable.
No sound.	Volume setting is low or turned off.	Adjust the volume.
MC36 turns off.	MC36 is inactive.	The display turns off after a period of inactivity. Set this period to 15 seconds, 30 seconds, 1, 2, 5, 10, or 30 minutes.
	Battery is depleted.	Recharge or replace the battery.
	Extreme battery temperature.	Move device to an area where the ambient temperature is between -10°C (+14 °F) and +60 °C (+140 °F).

Problem	Cause	Solution
A message appears stating not enough storage memory.	Too many applications installed on the MC36.	Remove user-installed applications on the MC36 to recover memory. Select  >  Apps>Downloaded. Select the unused programs and touch Uninstall.
The MC36 does not decode when reading bar code.	DataWedge is not enable.	Ensure that DataWedge is enabled and configured properly.Refer to the MC36 Integrator Guide for more information.
	Unreadable bar code.	Ensure the symbol is not defaced.
	Distance between the MC36 and bar code is incorrect.	Place the MC36 within proper scanning range.
	MC36 is not programmed for the bar code type.	Program the MC36 to accept the type of bar code being scanned. Refer to the MC36 Integrator Guide for Data Wedge configuration.
	MC36 is not programmed to generate a beep.	If the MC36 does not beep on a good decode, set the application to generate a beep on good decode.
MC36 cannot find any Bluetooth devices nearby.	Too far from other Bluetooth devices.	Move closer to the other Bluetooth device(s), within a range of 10 meters (32.8 feet).
	The Bluetooth device(s) nearby are not turned on.	Turn on the Bluetooth device(s) to find.
	The Bluetooth device(s) are not in discoverable mode.	Set the Bluetooth device(s) to discoverable mode. If needed, refer to the device's user documentation for help.

Chapter 8 Technical Specifications

The following sections provide technical specification for the device.

MC36 Technical Specifications

The following table summarize the MC36's intended operating environment and technical hardware specifications.

Table 8-1: MC36 Technical Specifications

Item	Description
Physical Characteristics	
Dimensions	Height: 166 mm (6.54 in.) Width: 75 mm (2.95 in.) Depth (with 2940 mAh battery): 21.3 mm (0.84 in.) Depth (with 4410 mAh battery): 27.8 mm (1.09 in.)
Weight	245 g (8.7oz) w/o battery
Display	4.3 in. color WVGA; 800 x 480, 300 NITs
Touch Panel	Gorilla Glass® 3
Backlight	LED backlight
Battery Pack	Rechargeable Lithium Ion 3.7V, 2,940 or 4,410 mAh Smart battery
Expansion Slot	User accessible microSD slot, up to 32 GB.
Connectivity	USB 2.0 (Host/Client)

Item	Description
Notification	LED, audio and vibration.
Keypad Options	Physical keyboard, On-screen keyboard and 4 capacitive front panel keys.
Audio	Speakers, noise cancelling microphones and headset connector (3.5 mm jack with microphone). One speaker, high-quality speaker phone; 3.5 mm headset jack and Bluetooth wireless headset support.
Physical Characteristics	
CPU	1.3 GHz Qual Core Processor
Operating System	Android-based, Android Open-Source Project (AOSP) 4.4.2.
Memory	1 GB RAM, 8 GB Flash
Output Power (USB)	300 mA
User Environment	
Operating Temperature	- 10 °C to 50 °C (14 °F to 122 °F)
Storage Temperature	-40 °C to 70 °C (-40 °F to 158 °F)
Charging Temperature	0° C to 40° C (32 °F to 104 °F)
Humidity	5% to 95% RH non-condensing
Drop Specification	Multiple 1.2 m (4 ft.) drops per MIL-STD 810G specifications. With protective boot: Multiple 1.2 m (4 ft.) drops to concrete across the operating temperature range,
Tumble Specification	150 0.5 m (1.5 ft.) tumbles (300 drops); With protective boot: 300 0.5 m (1.5 ft.) tumbles (600 drops); per applicable IEC682-32 tumble specifications.
Sealing	Ip67 per applicable IEC529 sealing specifications.
Wireless WAN Data and Voice Communications	
Wireless Wide Area Network (WWAN) radio	HSPA+, EDGE/GPRS/GSM, TD-SCDMA
Frequency band	GSM/EDGE: 900/1800MHz WCDMA: FDD1, FDD8 TD-SCDMA: TDD34, TDD39
GPS	Integrated, Autonomous, Assisted-GPS (A-GPS)

Item	Description
Wireless LAN Data Communications	
Wireless Local Area Network (WLAN) radio	IEEE® 802.11b/g/n with internal antenna
Data Rates Supported	802.11b: 1, 2, 5.5, 11 Mbps 802.11g: 6, 9, 12, 18, 24, 36, 48, 54 Mbps 802.11n: 15, 30, 45, 60Mbps Note that 802.11n data rates may be higher.
Operating Channels	Channel 1-13 (2412-2472 MHZ); actual operating channels/frequencies depend on regulatory rules and certification agency
Security Spreading Technique	Security Modes: Legacy, WPA and WPA2 Encryption: WEP (40/64 or 104/128 bit), TKIP and AES Authentication: TLS, TTLS (MS-CHAP), TTLS (MS-CHAP v2), TTLS (PAP), PEAP (MS-CHAP v2), PEAP (GTC). Direct Sequence Spread Spectrum (DSSS) and Orthogonal Frequency Division Multiplexing (OFDM)
Wireless PAN Data and Voice Communications	
Bluetooth	Class II, v 4.0; integrated antenna.
Data Capture	
Linear Imager	Captures 1D/2D bar codes.
Camera	5 MP auto-focus camera; Take photographs and videos.
Sensors	
Motion Sensor	3-axis accelerometer that enables motion sensing applications for dynamic screen orientation and power management.
Ambient Light Sensor	Automatically adjusts required display backlight to maximize power efficiency.
Proximity Sensor	Automatically detects when the user places the handset against head during a phone call to disable display output and touch input.



Zebra Technologies Corporation, Inc.
3 Overlook Point
Lincolnshire, IL 60069, U.S.A.
<http://www.zebra.com>

Zebra and the stylized Zebra head are trademarks of ZIH Corp., registered in many jurisdictions worldwide. All other trademarks are the property of their respective owners.

© 2017 ZIH Corp and/or its affiliates. All rights reserved.

MN002339A02 Revision A - July 2017